

DENIOS.

DENIOS AG

Dehmer Straße 58-66
32549 Bad Oeynhausen
Tel.: +49 (0)5731 7 53 – 0
Fax: +49 (0)5731 7 53 – 197
E-Mail: info@denios.com

Operation manual and spare parts list

HazMat station EPO

EPO-2 Part no.: 201603W

EPO-4 Part no.: 201604W

Description



EPO-2

HazMat station EPO-2 with open hose reel, for 2 oils in 60l or 200l barrels

HazMat station EPO-4 with open hose reel, for 4 oils in 60l or 200l barrels

Store oils in an environmentally sound way on economic 1,2 qm and dispense them directly into engines, gear boxes and axles. Our "Fresh oil-island" is always and everywhere ready to use - just a 230V supply away.

An increased variety of oils individually adapted to specific vehicle models and less consumption due to longer service intervals require innovative working tools.

- space-saving design
- economic
- efficient
- completely equipped
- environmentally sound

Technical data

- Sump tray with a volume of 210l and a mountin frame according to the German Water Resources Law (WHG)
- electric gear pumpwith suction unit
- automatic hose reels with 10m delivery hose
- filling pistols with swivel and electronic flow meter appropriate for calibration
- all components are mounted ready to use

WARNING

In order to avoid personal injury or material loss, please read the operation manuals!

Units may only be serviced or repaired if this should be necessary by authorized specialists or company representatives.

The following operation manuals are included:

- electric pump
- hose reel open
- electronic flow meter

INSTRUCTIONS

1. General instructions

The general instructions for storage systems, material no. 103041, in the current version, must be observed. National standards and safety regulations must be observed.

2. special instructions

Area of the grating must remain free as shown on the type label.

3. Use and intended purpose

The sump/storage system is used to enable drums of up to 200 litres capacity and cans and other small containers to be stored safely. 60 and 200 litre drums can be stored upright or on their side on drum mounts.



Only store substances to which the material of the sump is resistant. See the General Operating Instructions. Where hazardous materials of classes R10, R11 and R12 are being stored, 25% of the overall area (of the grids) must be left unoccupied. The sumps are approved for the storage of materials in hazard classes WGK 1-3 and flammable liquids with a flash point > 55 °C.

4. Technical details

The HazMat station is manufactured from steel, with an integrated sump and is compliant with European building regulations. The sump capacity is 205 litres.

5. Assembly

- Place the storage system on level ground.
- The accessories facilitate loading, storage and dispensing from the sump.

6. Specifications

See type label.

7. Operation

After opening the lid / safety bracket (optional) the drums can be placed in the hazardous material station using suitable equipment. Close lid / safety bracket (optional).

For types 4 GST-K and 4 GST-KS before closing the lid the blocking device of the left gas spring must be released.



When storing combustible fluids comply with the fire and explosion protection regulations!
For hazard classes R10, R11 and R12 the free areas of 25% of the total area (gratings) must be adhered to. (Exception: GST-KS and Depot AI)
Check drums are positioned safely and secure to prevent falling over or down!
Only store drums horizontally on drum stands!



Safe filling is possible over the collecting sump.



Access to the hazardous materials station by unauthorised persons is prohibited!

8. Maintenance and servicing



The inspection and maintenance of the storage system/sump must be carried out in accordance with the directions in the general operating instructions enclosed in the annex. When replacing parts only the manufacturer's original parts may be used.

DENIOS.

DENIOS AG

Dehmer Straße 58-66
32549 Bad Oeynhausen
Tel.: +49 (0)5731 7 53 – 0
Fax: +49 (0)5731 7 53 – 197
E-Mail: info@denios.com

Operation manual and spare parts list

Automatic hose reel - open

Description

Automatic single arm hose reel open - serie 506

Professional automatic single arm hose reel for oil, with delivery hose 10m nom. diam 1/2"

Inlet thread 1/2" f/m

Outlet thread 1/2" f/m

Working pressure 100 bar



Installation

Hose reel can be installed directly on the fixing surface or using a plate (Fig. A) or a pivoting bracket (Fig. B).

For achieving the reel optimal operation; its hose guide arm can be mounted in these positions:

- Perpendicular reeling:
Recommended for ceiling and wall or column under 2.5 m (8 feet) (see Fig. 2).
- Side reeling:
Recommended for wall, column, bench, tank, etc (see Fig. 3).
- Tangential reeling:
Recommended for wall or column at a height above 2.5 m (8 feet), mobile units, lube truck, tank assemblies, etc. (see Fig. 4).

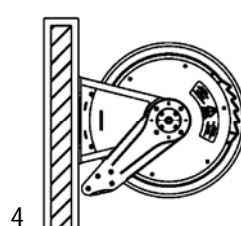
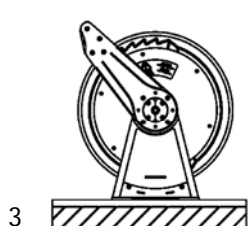
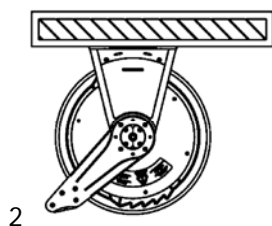

A

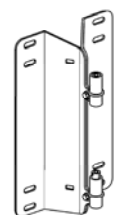

5

Installation

To reposition the hose guide arm, follow these steps:

- Clamp the spool with c-clamp to lock the hose reel (Fig. C).
- Remove the hose-stop.
- Unscrew the fixing screws (Fig. 5).
- Place the hose guide arm in the required position and screw the fixing screws.
- Insert the hose reel through the hose outlet and assemble the hose-stop. Affix the hose-stop.
- Unlock the spool.

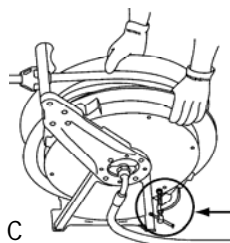

C

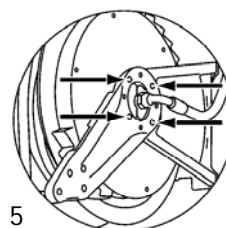

5

Hose installation

- Clamp the hose reel firmly to a work bench.
- Pretension the hose reel power spring by rotating the spool: 10m spring: 16 turns.
- Introduce the hose end to fix to the hose reel through the outlet guide and then through the opening in the drum of the spool. Pull the hose through the drum towards the swivel.
- Fix the hose to the swivel as indicated in Figure 8a and fix the U bolt as shown in Figure 8b.
- Fix the hose stop to the free end of the outlet hose.
- Pull out the hose slightly to free the spool latch and then gradually release the hose to allow the hose reel to windup the hose.
- If the hose reel does not rewind satisfactorily then adjust the tension of the power spring (see "Spring load adjustment").

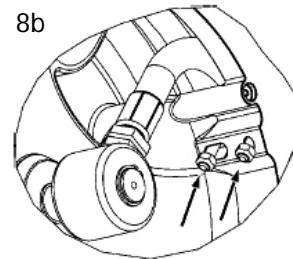
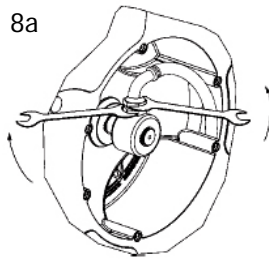

Hose replacement

WARNING: Before removing the damaged hose, close the nearest shut off valve to the reel and open the fluid control gun to release the pressure inside the hose.

- Unwind the hose completely and then search for the ratchet blocking position (Fig. 6).
- Remove the hose stopper (Fig. 7).
- Disconnect the hose as seen (Fig. 8a). Release the hose from the disk by removing the clamp (Fig. 8b).
- Pass the new hose through the hose outlet and connect it again to the hose reel. Assemble the clamp and assemble the hose stopper to the required length.
- Pull the hose hard enough to release the latch, and slowly allow the hose to retract (Fig. 9).

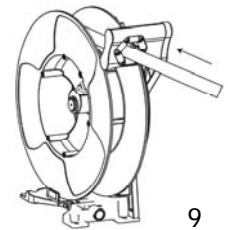
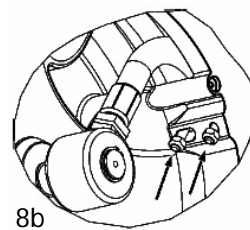
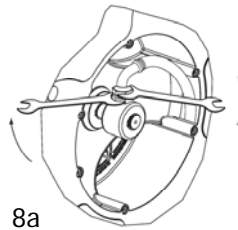
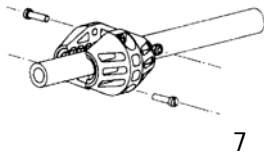
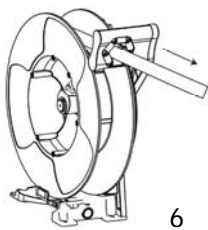

Spring load adjustment

To increase spring tension

- Pull the hose out 10 feet (3 meters) and let the hose get latched (Fig. 11).
- Wind the hanging hose in the reel (Fig. 13).
- Gently pull the hose, it is automatically winded (Fig. 14).
- Repeat if more spring tension is required.

To decrease spring tension

- Pull the hose out 10 feet (3 meters) and let the hose get latched (Fig. 11).
- Unwind one wrap and pull the hose (Fig. 12).
- Gently pull the hose, the hose is automatically wind-ed (Fig. 14).
- Repeat if less spring tension is required.

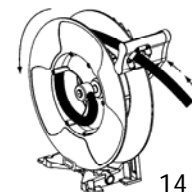
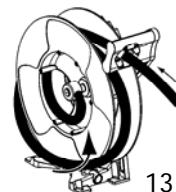
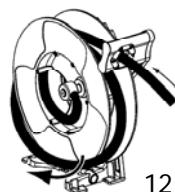
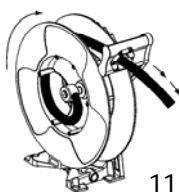

Swivel replacement

WARNING: Before removing the old swivel, close the nearest shut off valve to the reel and open the fluid control gun to release the pressure inside the hose.

- Pull the hose out and let the hose get latched (Fig. 15).
- Unscrew the nuts with two spanners (Fig. 16).
- Remove the circlip and pull the swivel. Be careful not to damage the swivel O-Ring (Fig. 17).
- Assemble the new swivel and re-assemble the pieces in reverse order.

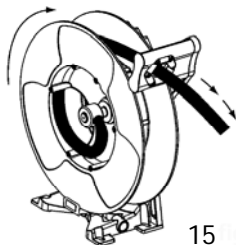

15

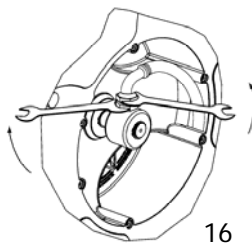

16

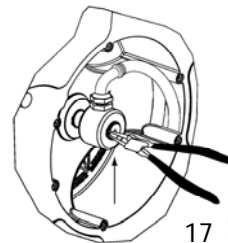

17

Ratchet replacement

- Remove the nut that fixes the latch (Fig. 18).
- Replace the latch and/or the latch spring.
- Re-assemble the pieces in reverse order.

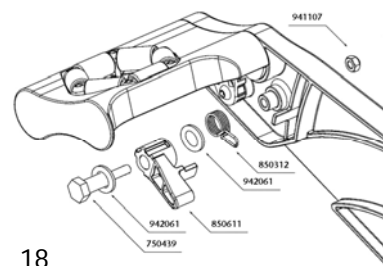

18

Troubleshooting

Symptom	Possible causes	Solution
Hose does not rewind	Spring is not tensioned enough	Increase spring tension
Leaking hose reel	Hose has a hole or is damaged	Replace the hose
Leaking swivel	Damaged swivel rings	Replace the swivel rings
Hose does not extend out as much as required	Spring is over tensioned	Decrease spring tension
Hose reel does not latch	Damaged ratchet	Replace the ratchet
	Ratchet not fitted	Assemble the ratchet properly
	Damaged spring ratchet	Change the ratchet spring

EC Declaration of Conformity

SAMOA INDUSTRIAL, S.A., Alto de Pumarín, s/n, 33211 - Gijón - Spain, declares declares that the hose reels 506 XXX conform(s) with the EU Directive(s): (2006/42/EEC)

For SAMOA INDUSTRIAL, S.A.

Pedro E. Prallong Alvarez
Production Director

Parts list

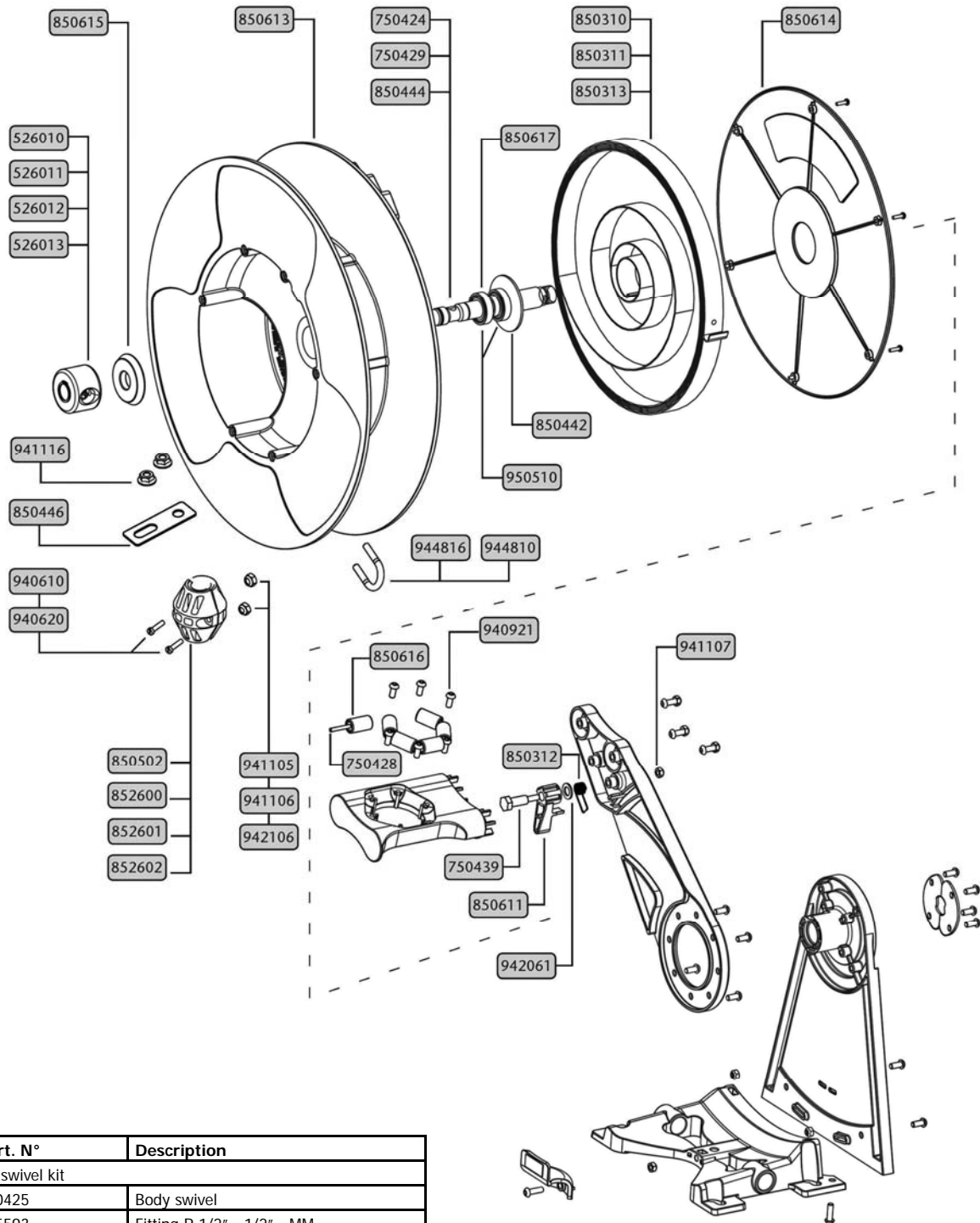

Kit number	Part. N°	Description
526010	Oil swivel kit	
	750425	Body swivel
	945593	Fitting R 1/2" - 1/2" - MM
	946032 (x2)	O-ring NBR
526020	Ratchet kit	
	850312	Ratchet spring
	750439	Ratchet Axle
	850611	Ratchet
	941107	Nut AISI 316
	942061	Washer AISI 316
526021	Hose outlet kit	
	850616 (x6)	Hose roller
	750428 (x6)	Roller axle
	940921 (x6)	Screw AISI 316
526001	Hose-stop and U-bolt kit (oil 1/2")	
	944816	U-bolt AISI 316
	941126 (2)	Nut AISI 316
	852601 (2)	Hose-stop
	940610 (2)	Screw
	941105 (2)	Nut
		Plate u-bolt AISI 316

Kit number	Part. N°	Description
526023	Spool and fluid reel shaft kit	
	850615	Washer
	850613	Spool
	750424	Low-medium pressure shaft
	950510 (x2)	Ball bearing
	850617	Spacer
	850614	Spring cover
	940522 (x6)	Screw
	850442	Spring washer
Part. N°	Description	
850310	Standard spring (10 m)	