



KERN & Sohn GmbH

Ziegelei 1
D-72336 Balingen
E-Mail: info@kern-sohn.com

Tel: +49-[0]7433-9933-0
Fax: +49-[0]7433-9933-149
Internet: www.kern-sohn.com

Operating instruction Precision balance

KERN PES/PEJ

Version 1.8
2017-11
GB



PES/PEJ-BA-e-1718



KERN PES/PEJ

Version 1.8 2017-11

Operating instruction Precision balance

Contents

1.	Technical data.....	5
2.	Declaration of conformity	10
3.	Basic Information (General).....	11
3.1.	Proper use	11
3.2.	Improper Use.....	11
3.3.	Warranty	11
3.4.	Monitoring of Test Resources	12
4.	Basic Safety Precautions	12
4.1.	Pay attention to the instructions in the Operation Manual	12
4.2.	Personnel training	12
5.	Transport and storage.....	12
5.1.	Testing upon acceptance.....	12
5.2.	Packaging.....	12
6.	Unpacking, Setup and Commissioning	13
6.1.	Installation Site, Location of Use.....	13
6.2.	Unpacking	13
6.3.	Scope of delivery	15
6.4.	Setup.....	15
6.5.	Mains connection.....	16
6.6.	Internal battery operation (cannot be reequipped)	16
6.7.	Terminal for external devices	16
6.8.	Initial Commissioning.....	17
6.8.1.	Power display	17
6.8.2.	Bar graph display.....	18
6.8.3.	Stability display.....	18
6.8.4.	Balance zero display.....	18
6.9.	Adjustment	19
6.9.1.	Adjustment with external weight (only PES).....	19
6.9.2.	Adjustment test with external weight (only PES).....	21

6.9.3.	Automatic adjustment (only PEJ)	23
6.9.4.	Adjustment with internal weight (only PEJ).....	24
6.9.5.	Adjustment test with internal weight (only PEJ)	25
6.10.	Verification.....	27
6.10.1.	Seals and unlocking switch	28
7.	Application and configuration menu 1.....	29
7.1.	User principle of the menu control.....	29
7.2.	Menu overview	31
7.2.1.	Parameter additional functions.....	32
7.2.2.	Parameter for serial interface.....	33
8.	Configuration menu 2.....	36
8.1.	User principle of the menu control.....	36
8.2.	Menu overview	37
9.	Operation.....	38
9.1.	Keyboard overview	38
9.2.	Overview of display	39
10.	Weighing mode	40
10.1.	Weighing	40
10.1.1.	Taring	41
10.1.2.	Net/gross.....	43
10.2.	Parts counting	44
10.3.	Percent determination	47
10.3.1.	Entering the reference weight by weighing	47
10.3.2.	Numeric entering of the reference weight.....	48
10.4.	Density determination of solids (hydrostatic weighing).....	51
11.	Adding of displayed values	55
11.1.	Adding with AUTO-TARE.....	56
12.	Weighing with tolerance range.....	57
12.1.	General Information	57
12.2.	Display of the results	58
12.2.1.	For 2 limits	58
12.2.2.	For 3 or 4 limits.....	59
12.3.	Basic settings for weighings with tolerance range.....	59
12.4.	Evaluation of absolute values	60
12.4.1.	Entering 2 limits by weighing.....	60
12.4.2.	Entering 3 or 4 limits by weighing	63

12.4.3.	Numeric entering of 2 limits	66
12.5.	Evaluation with difference values.....	69
12.5.1.	Entering 2 limits by weighing.....	69
12.5.2.	Entering 3 or 4 limits by weighing	72
12.5.3.	Numeric entering of 2 limits	72
13.	Setting date and time.....	75
13.1.	Time.....	75
13.2.	Date	77
13.3.	Interval output function	79
13.3.1.	Interval setting.....	79
13.3.2.	Start/Stop interval output	80
13.4.	Input balance ID-no.	81
14.	Data output.....	83
14.1.	RS 232C interface.....	83
14.2.	Printer interface (unidirectional data exchange)	84
14.3.	Description of interface	84
14.4.	Data output	85
14.4.1.	Format for data transmission.....	85
14.4.2.	Signs	85
14.4.3.	Data	85
14.4.4.	Units	86
14.4.5.	Result evaluation for balances with tolerance range.....	86
14.4.6.	Data status.....	87
14.4.7.	Interval data output.....	87
14.4.8.	Output time	87
14.5.	Remote control instructions	88
15.	Service, maintenance, disposal.....	89
15.1.	Cleaning	89
15.2.	Service, maintenance.....	89
15.3.	Disposal	89
16.	Instant help.....	89

1. Technical data

KERN	PES 620-3M
Readability (d)	0.001 g
Weighing range (max)	620 g
Minimum load (Min)	0.1 g
Verification value (e)	0.01 g
Accuracy class	I
Reproducibility	0.001 g
Linearity	± 0.003 g
Stabilization time	3 sec.
Recommended adjusting weight, not included (class)	500 g (E2)
Vibration filter	4
Minimum piece weight	0.001 g
Reference quantities	5, 10, 30, 100
Net weight (kg)	4kg
Permissible ambient condition	10° C to 30° C
Humidity of air	max. 80 % relative (not condensing)
Weighing Units	g, kg, ct
Weighing plate, stainless steel	140 x 120 mm
Dimensions of the housing (B x D x H)	220 x 330 x 93 mm
Mains connection	Mains adaptor 220V-240V; AC; 50Hz
Rechargeable battery (optional)	Operating time ca. 6 h. / charging time ca. 12 h

KERN	PES 2200-2M	PES 4200-2M	PES 6200-2M
Readability (d)	0.01 g	0.01 g	0.01 g
Weighing range (max)	2,200 g	4,200 g	6,200 g
Minimum load (Min)	0.5 g	0.5 g	1 g
Verification value (e)	0.1 g	0.1 g	0.1 g
Accuracy class	II	II	I
Reproducibility	0.01 g	0.01 g	0.01 g
Linearity	± 0.02 g	± 0.02 g	± 0.03 g
Stabilization time	3 sec.	3 sec.	3 sec.
Recommended adjusting weight, not included (class)	2 kg (F1)	2 x 2 kg (E2)	5 kg (E2)
Vibration filter	4		
Minimum piece weight	0.01g		
Reference quantities	5, 10, 30, 100		
Net weight (kg)	4kg		
Permissible ambient condition	10° C to 30° C		
Humidity of air	max. 80 % relative (not condensing)		
Weighing Units	g, kg, ct		
Weighing plate, stainless steel	200 x 200 mm		
Dimensions of the housing (B x D x H)	220 x 333 x 93 mm		
Mains connection	Mains adaptor 220V-240V; AC; 50Hz		
Rechargeable battery (optional)	Operating time ca. 6 h. / charging time ca. 12 h		

KERN	PES 15000-1M	PES 31000-1M
Readability (d)	0.1 g	0.1 g
Weighing range (max)	15,000 g	31,000 g
Minimum load (Min)	5 g	5 g
Verification value (e)	1 g	1 g
Accuracy class	II	II
Reproducibility	0.1 g	0.1 g
Linearity	± 0.2 g	± 0.4 g
Stabilization time	3 sec.	3sec.
Recommended adjusting weight, not included (class)	10 kg + 5 kg (F1)	20 kg+10 kg(F1)
Vibration filter	4	8,9
Minimum piece weight	0.1g	0.5 g
Reference quantities	5,10, 30, 100	
Net weight (kg)	4	8.9
Permissible ambient condition	10° C to 30° C	
Humidity of air	max. 80 % relative (not condensing)	
Units	g, kg, ct	
Weighing plate, stainless steel	200x200 mm	250x220mm
Dimensions of the housing (B x D x H)	220x333x93 mm	260x330x110
Mains connection	Mains adaptor 220V-240V; AC; 50Hz	
Rechargeable battery (optional)	Operating time ca. 6 h. / charging time ca. 12 h	

KERN	PEJ 620-3M
Readability (d)	0.001 g
Weighing range (max)	620 g
Minimum load (Min)	0.1 g
Verification value (e)	0.01 g
Accuracy class	I
Reproducibility	0.001 g
Linearity	± 0.003 g
Stabilization time	3 sec.
Adjustment weight	internal
Vibration filter	4
Minimum piece weight	0.001g
Reference quantities	5, 10, 30, 100
Net weight (kg)	4kg
Permissible ambient condition	10° C to 30° C
Humidity of air	max. 80 % relative (not condensing)
Weighing Units	g, kg, ct
Weighing plate, stainless steel	140 x 120 mm
Dimensions of the housing (B x D x H)	220 x 333 x 93 mm
Mains connection	Mains adaptor 220V-240V; AC; 50Hz
Rechargeable battery (optional)	Operating time ca. 6 h. / charging time ca. 12 h

KERN	PEJ 2200-2M	PEJ 4200-2M
Readability (d)	0.01 g	0.01 g
Weighing range (max)	2,200 g	4,200 g
Minimum load (Min)	0.5 g	0.5 g
Verification value (e)	0.1 g	0.1 g
Accuracy class	II	II
Reproducibility	0.01 g	0.01 g
Linearity	± 0.02 g	± 0.02 g
Stabilization time	3 sec.	
Adjustment weight	internal	
Vibration filter	4	
Minimum piece weight	0.01 g	
Reference quantities	5,10, 30, 100	
Net weight (kg)	6	
Permissible ambient condition	10° C to 30° C	
Humidity of air	max. 80 % relative (not condensing)	
Units	g, kg, ct	
Weighing plate, stainless steel	200 x 200 mm	
Dimensions of the housing (B x D x H)	220 x 333 x 93 mm	
Mains connection	Mains adaptor 220V-240V; AC; 50Hz	
Rechargeable battery (optional)	Operating time ca. 6 h. / charging time ca. 12 h	

2. Declaration of conformity

To view the current EC/EU Declaration of Conformity go to:

www.kern-sohn.com/ce

- i** The scope of delivery for verified weighing balances (= conformity-rated weighing balances) includes a Declaration of Conformity.

3. Basic Information (General)

3.1. Proper use

The balance you purchased is intended to determine the weighing value of material to be weighed. It is intended to be used as a “non-automatic“ balance, i.e. the material to be weighed is manually and carefully placed in the centre of the weighing plate. As soon as a stable weighing value is reached the weighing value can be read.

3.2. Improper Use

Do not use balance for dynamic weighings. In the event that small quantities are removed or added to the material to be weighed, incorrect weighing results can be displayed due to the “stability compensation“ in the balance. (Example: Slowly draining fluids from a container on the balance.)

Do not leave permanent load on the weighing plate. This may damage the measuring system. Impacts and overloading exceeding the stated maximum load (max) of the balance, minus a possibly existing tare load, must be strictly avoided. This could cause damage to the balance.

Never operate balance in explosive environment. The serial version is not explosion protected. The structure of the balance may not be modified. This may lead to incorrect weighing results, safety-related faults and destruction of the balance.

The balance may only be used according to the described conditions. Other areas of use must be released by KERN in writing.



The appliance may only be opened by trained service technicians according to KERN standards.

Before opening, disconnect appliance from power supply!
Warranty claims will be voided when appliance is opened.



The **PES/PEJ** weighing system may not be used in explosive areas or areas with explosive substances.

3.3. Warranty

Warranty claims shall be voided in case

- our conditions in the operation manual are ignored
- the appliance is used outside the described uses
- when the appliance is modified or opened
- mechanical damage and damage caused by media, liquids
- natural wear and tear
- the appliance is improperly set up or incorrectly electrically connected
- the measuring system is overloaded

3.4. Monitoring of Test Resources

In the framework of quality assurance the measuring-related properties of the balance and, if applicable, the testing weight, must be checked regularly. The responsible user must define a suitable interval as well as type and scope of this test. Information is available on KERN's home page (www.kern-sohn.com) with regard to the monitoring of balance test substances and the test weights required for this. In KERN's accredited DKD calibration laboratory test weights and balances may be calibrated (return to the national standard) fast and at moderate cost.

4. Basic Safety Precautions

4.1. Pay attention to the instructions in the Operation Manual



Carefully read this operation manual before setup and commissioning, even if you are already familiar with KERN balances.

Versions in other languages are non-binding translations.
The only binding version is the original document in German.

4.2. Personnel training

The appliance may only be operated and maintained by trained personnel.

5. Transport and storage

5.1. Testing upon acceptance

When receiving the appliance, please check packaging immediately, and the appliance itself when unpacking for possible visible damage.

5.2. Packaging

Keep all parts of the original packaging in case you need to return the appliance.

Only use original packaging for returning.

Before sending, disconnect all connected cables and loose/movable parts.

Attach possibly existing transport safeguards. Secure all parts, e.g. glass windshield, weighing plate, power unit etc., to prevent slipping and damage.

6. Unpacking, Setup and Commissioning

6.1. Installation Site, Location of Use

The balances are designed in a way that reliable weighing results are achieved in common conditions of use.

You will work accurately and fast, if you select the right location for your balance.

Therefore, observe the following for the installation site:

- Place the balance on a firm, level surface;
- Avoid extreme heat as well as temperature fluctuation caused by installing next to a radiator or in the direct sunlight;
- Protect the balance against direct draughts due to open windows and doors;
- Avoid jarring during weighing;
- Protect the balance against high humidity, vapours and dust;
- Do not expose the device to extreme dampness for longer periods of time. Non-permitted condensation (condensation of air humidity on the appliance) may occur if a cold appliance is taken to a considerably warmer environment. In this case, acclimatize the disconnected appliance for ca. 2 hours at room temperature.
- Avoid static charging of the material to be weighed, weighing container and windshield.

If electro-magnetic fields or static charge occur, or if the power supply is unstable major deviations on the display (incorrect weighing results) are possible. In that case, the location must be changed.

6.2. Unpacking

Carefully remove the balance from the packaging, remove plastic cover and setup balance at the intended workstation.

Your balance in overview:

English

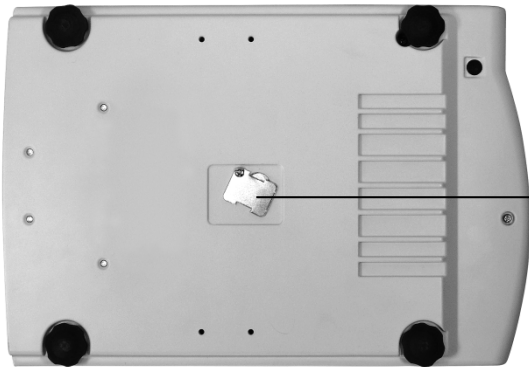

Rear view:

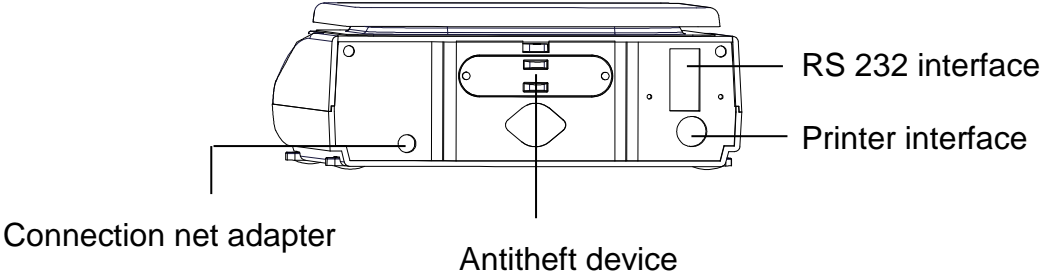

6.3. Scope of delivery

Serial accessories:

- Balance
- Weighing plate
- Mains power supply
- Operating Manual
- Protective cover

6.4. Setup

Positioning of weighing plate:

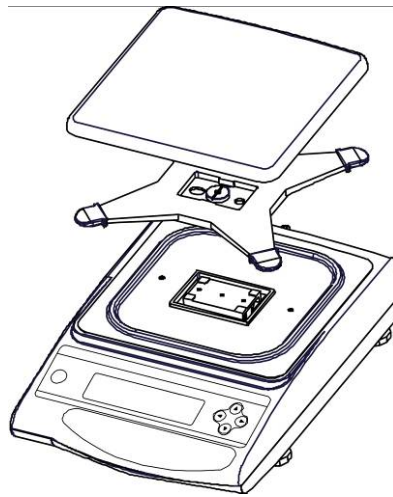

Levelling balance:

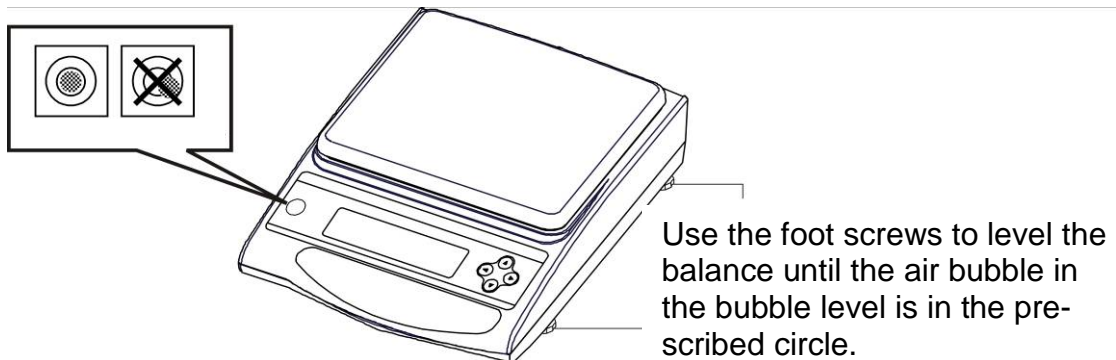

6.5. Mains connection

Power is supplied via the external mains power supply. The stated voltage value must be the same as the local voltage.

Only use original KERN mains power supplies. Using other makes requires consent by KERN.

In the menu you can activate the AUTO-SLEEP function [R. R.5. 1]. In net operation the balance after 3 min without load change or key pressure passes in a sleep mode. Automatic activation of the display by load change or by pressing any key.



6.6. Internal battery operation (cannot be reequipped)

The optionally supplied battery is charged with the supplied power supply.

Before the first use, the battery should be charged by connecting it to the mains power supply for at least 15 hours. The operating time of the battery is about. 6h; charging time until complete recharging ca. 15h.

In the menu you can activate the AUTO-OFF function [9 R.P. 1]. After 3 min without load change the balance switches automatically off in order to spare the battery.

When the balance is in battery mode the following symbols appear on the display:

	Battery charge sufficient
	Battery very low. To charge the battery, connect it to the mains as soon as possible (re-calibration not possible).
 flashes	Voltage has dropped below prescribed minimum. Plug in the mains adapter, to charge the balance via the electrical network (15h).

6.7. Terminal for external devices

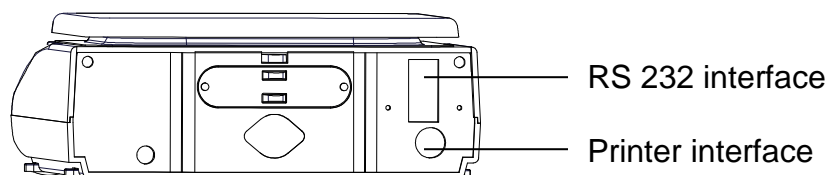





6.8. Initial Commissioning

A warming up time of 10 minutes after switching on stabilizes the measuring values.

The accuracy of the balance depends on the local acceleration of gravity.

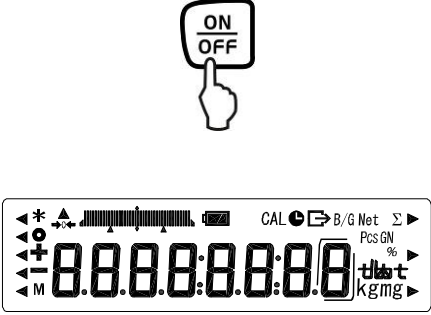
Please be sure to observe the information in the chapter on adjusting in **chap. 6.9**.

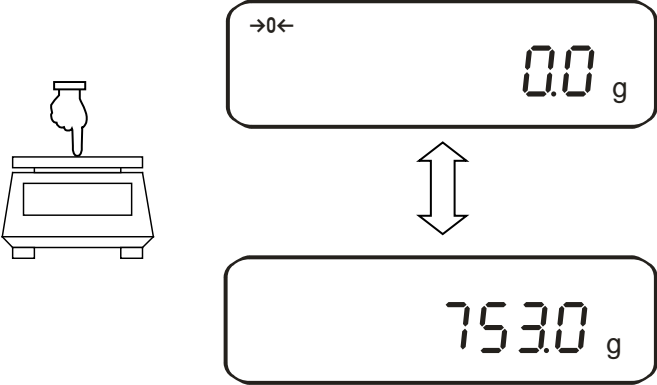
6.8.1. Power display

 <p>The balance will carry out a self-test</p>	<p>Supply balance with power via the mains power supply.</p> <p>Balance is in stand-by mode (green LED is on).</p> <p>Use the -key to switch the balance on.</p>
	<p>By pressing lightly it is possible to check whether the balance display changes.</p>
<p>Stand-by ■</p>	<p>Use the -key to switch the balance off. The balance is now in stand-by mode again (green LED is on).</p>

6.8.2. Bar graph display

In configuration menu 1 (chapter 7) you can activate/deactivate the bar graph display.

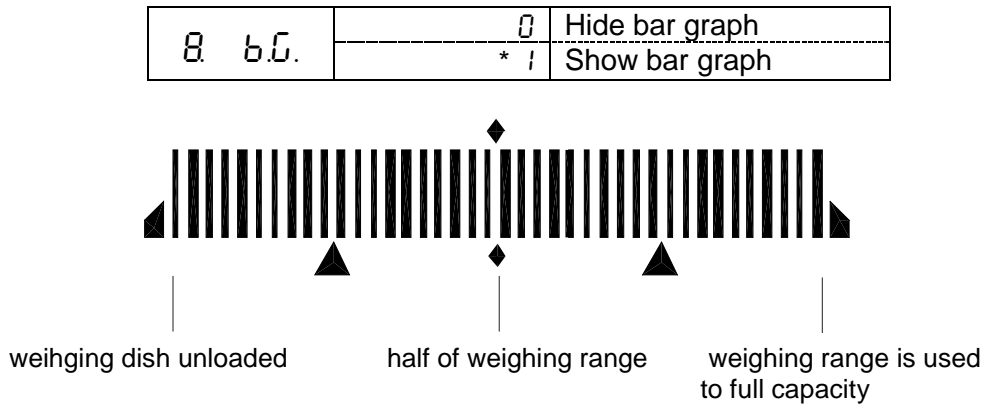

The weighing range of the balance is divided into 40 graphic cuboids. Zero (0) will appear on the graphic display if there is no weighing value on the balance. 20 graphic cuboids are displayed if the balance is loaded up to one half of its weighing range.

6.8.3. Stability display

Stable

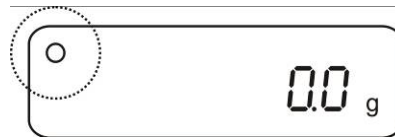

Unstable



If the display shows the stability display **[o]** the balance is in a stable status. The **[o]** indication disappears if the condition is unstable.

6.8.4. Balance zero display

Environmental influences can lead to the exact figure of “000.0” not being displayed in spite of an empty weighing dish. It is, however, possible to reset your balance to zero at any time and thus ensure that weighing really does commence at zero. Setting to zero when a weight is applied is only possible within a certain type-dependent range. In the event that the balance cannot be reset to zero with an applied weight, this range has been exceeded. **[o - Err]** will appear on the display.

If an exact zero reading is not displayed on the balance in spite of the weighing dish being empty, press the TARE key and the balance will start resetting to zero. Your balance will be set to zero after a short standby time.

In addition to this, the sign for the balance zero setting will be displayed **[→0←]**.

6.9. Adjustment

As the acceleration value due to gravity is not the same at every location on earth, each balance must be coordinated - in compliance with the underlying physical weighing principle - to the existing acceleration due to gravity at its place of location (only if the balance has not already been adjusted to the location in the factory). This adjustment process must be carried out at every commissioning, after each change of location as well as in case of fluctuating environment temperature. To receive accurate measuring values it is also recommended to adjust the balance periodically in weighing operation.

6.9.1. Adjustment with external weight (only PES)

Adjustment should be carried out with the recommended adjusting weight (see Chapter 1 „Technical Data“). The adjustment can also be carried out with different adjusting weights (see table), but not ideal from a metrological point of view.

Model	Recommended adjusting weight	Not ideal for metrological adjustment
PES 620-3M	500 g (E2)	300 g
PES 2200-2M	2 kg (F1)	1000 g
PES 4200-2M	2 x 2 kg (E2)	2000 g
PES 6200-2M	5 kg (E2)	3000 g
PES 15000-1M	10 kg + 5 kg (F1)	7000 g







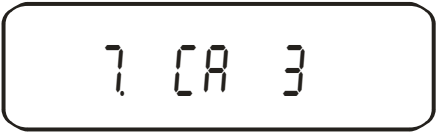

Information concerning the adjusting weights is available at: <http://www.kern-sohn.com>

Procedure when adjusting:

Observe stable environment conditions. A warming-up time of ca. 30 minutes for stabilisation is necessary. Ensure that there are no objects on the weighing plate.

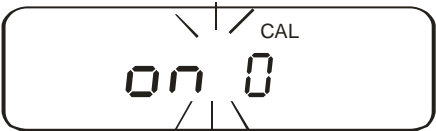
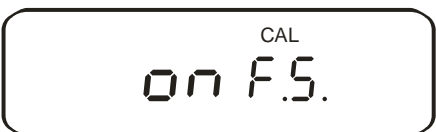
At verified balances, the adjustment is locked by a switch (except accuracy class I).

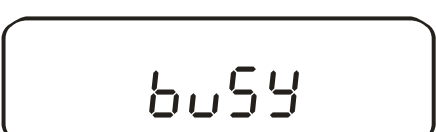
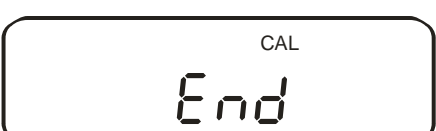
In order to adjust, open the locking switch see chap.6.10.1 (except accuracy class I).

Operation	Display
<p>Activate function [7] [CAL] [3] (see chap. 7).</p>	 <p style="text-align: center;">↓</p> 
<div style="text-align: center;">  <p>Zero point will be saved.</p> </div>	 <p style="text-align: center;">↓</p> 
<p>Carefully place adjusting weight in the centre of the weighing plate</p> <p>Adjustment process is started.</p> <p>The process of adjustment is completed.</p> <p>Remove adjusting weight, balance will return into weighing mode automatically. In case of an adjustment error or incorrect adjusting weight the display will show [- Err]; repeat adjustment process.</p>	 <p style="text-align: center;">↓</p>  <p style="text-align: center;">↓</p>  <p style="text-align: center;">↓</p>  <p style="text-align: center;">↓</p> 

6.9.2. Adjustment test with external weight (only PES)

During adjustment tests the balance automatically compares the saved value of the adjustment weight with the actual value. This is only a check, i.e. no values are changed.

Procedure:

Observe stable environmental conditions. A warming up time of ca. 1 hour is required for stabilization. Ensure that there are no objects on the weighing plate.

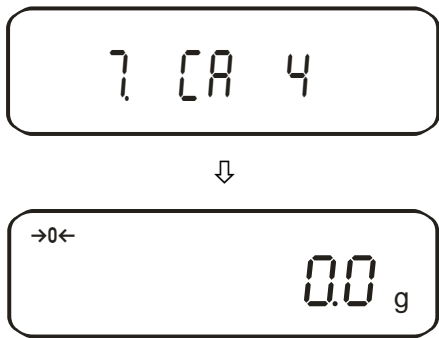
Operation	Display
Activate function [7] [A.4] (see chap. 7).	

Start of the adjustment test:



Carefully place adjusting weight in the centre of the weighing plate

The difference between the saved value and the measured value is displayed.

Take away adjustment weight.

Press any key; the adjustment process is cancelled and the balance returns to weighing mode.

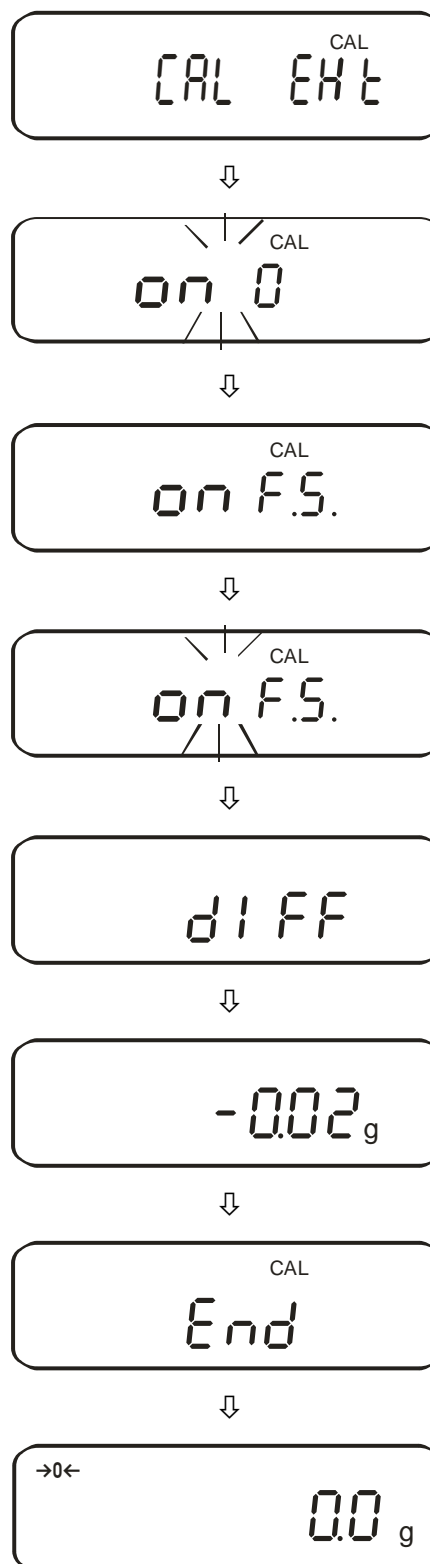

6.9.3. Automatic adjustment (only PEJ)

After switching on the balance, the automatic adjustment starts with the internal adjustment weight.

Switch on the balance using ON/OFF.

The balance carries out a selftest, „M“ will be displayed flashing.

After that the automatic adjustment starts:

„Aut. CAL“ appears flashing,

followed by „CH. 0“ and „CH. F.S.“

If „End“ is displayed, the automatic adjustment has been concluded successfully.

The balance changes into weighing mode thus being ready for weighing.

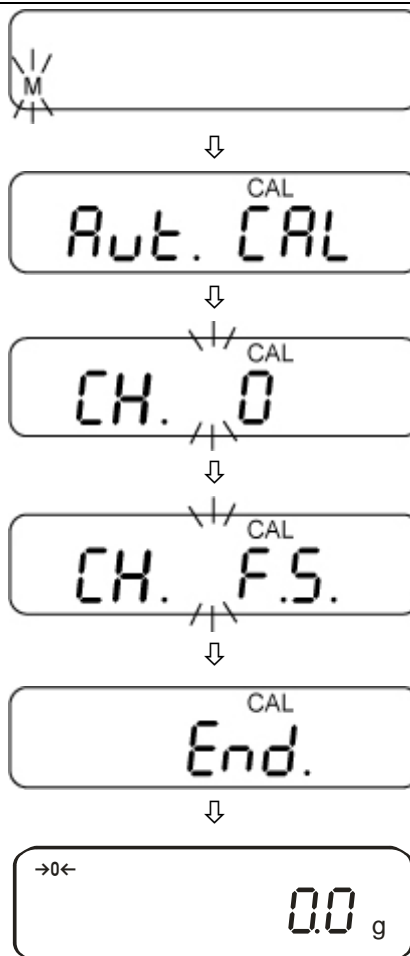





6.9.4. Adjustment with internal weight (only PEJ)

With the internal adjustment weight, the weighing accuracy can be checked and re-adjusted at any time.

Procedure when adjusting:

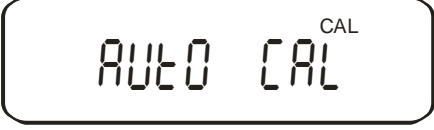
Observe stable environmental conditions. A warming up time of ca. 1 hour is required for stabilization. Ensure that there are no objects on the weighing plate.

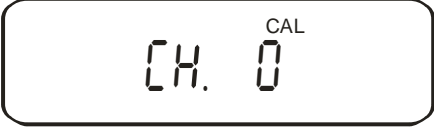
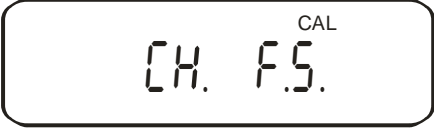
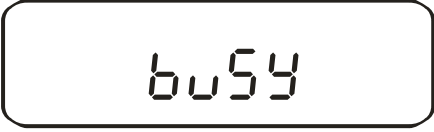
Operation	Display
Activate function [7] [CAL] (see chap. 7).	 ↓ 
Start of the automatic adjustment:  Adjustment is carried out automatically.	 ↓  ↓  ↓  ↓  ↓
The process of adjustment is completed.	
The balance returns automatically into weighing mode.	

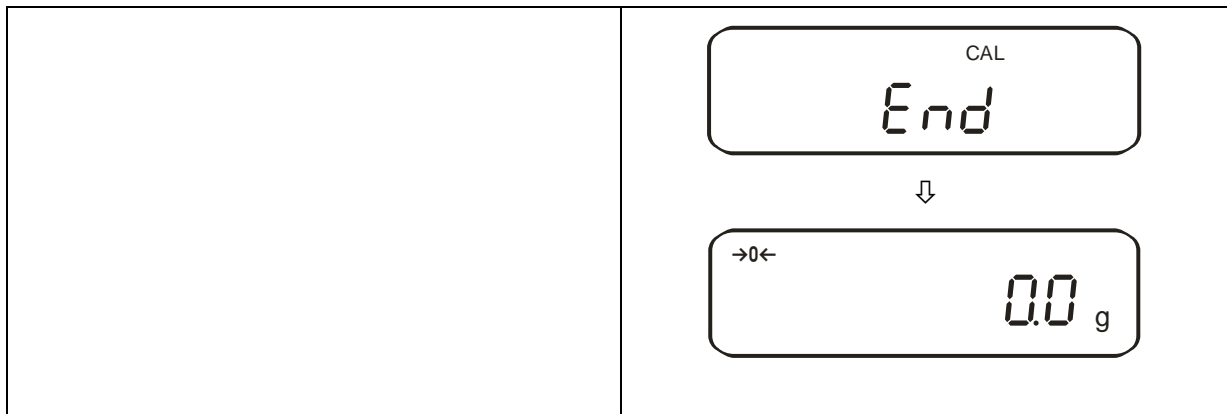









6.9.5. Adjustment test with internal weight (only PEJ)

During adjustment tests the balance automatically compares the saved value of the adjustment weight with the actual value. This is only a check, i.e. no values are changed.

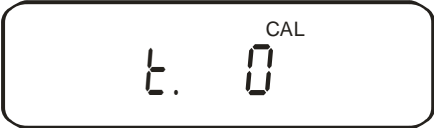
Procedure:

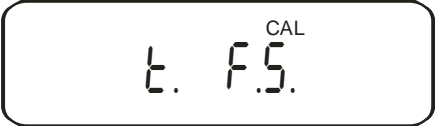
Observe stable environmental conditions. A warming up time of ca. 1 hour is required for stabilization. Ensure that there are no objects on the weighing plate.

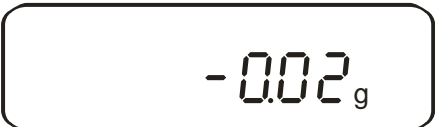
Operation	Display
Activate function [7] [CAL] (see chap. 7).	 ↓ 
Start of the adjustment test:  The test is carried out automatically.	 ↓  ↓  ↓

	
<p>The difference between the saved value and the measured value is displayed.</p> <p>Press any key; the adjustment process is cancelled and the balance returns to weighing mode.</p>	 <p>↓</p>  <p>↓</p>  <p>↓</p> 

6.10. Verification

General introduction:

According to EU directive 2014/31/EU balances must be officially verified if they are used as follows (legally controlled area):

- a) For commercial transactions if the price of goods is determined by weighing
- b) For the production of medicines in pharmacies as well as for analyses in the medical and pharmaceutical laboratory
- c) For official purposes.
- d) For manufacturing final packages.

In cases of doubt, please contact your local trade in standard.

Verification instructions

An EU type approval exists for balances described in their technical data as verifiable. If a balance is used where obligation to verify exists as described above, it must be officially verified and re-verified in regular intervals.

Re-verification of a balance is carried out according to the respective national regulations. The validity for verification of balances in Germany is e.g. 2 years.

The legal regulation of the country where the balance is used must be observed!

Balances with obligation to verify must be taken out of operation if:

- **The weighing result of the balance is outside the error limit.** Therefore, in regular intervals load balance with known test weight (ca. 1/3 of the max. load) and compare with displayed value.
- **The re-verification deadline has been exceeded.**

Before models PES 2200-2M, PES 4200-2M, PES 15000-1M are verified, the adjustment function „7. [R. 4“ must be activated.

Therefore, external adjustment in verification mode is impossible

6.10.1. Seals and unlocking switch

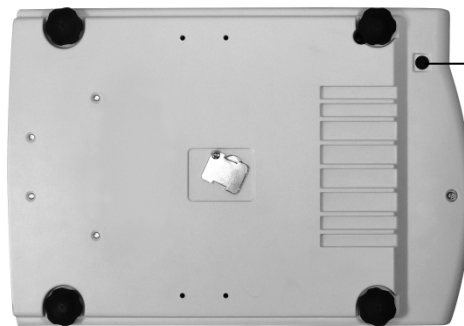

- Position:
- Unlocking switch
 - Seal



Seal

After verification the balance is sealed at the indicated positions.
Verification of the balance is invalid without the "seal".

Access to the unlocking switch by removing the seal (verification will be invalid!) and the rubber plug (see drawing).





Position of unlocking switch	Status
forwards	Balance is unlocked for the adjustment process, adjustment will be possible
backwards	Verification position - Adjustment locked







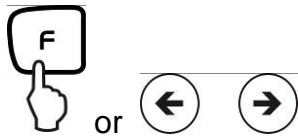

7. Application and configuration menu 1

In the menu the settings of the balance can be modified and functions can be activated. This way, the balance can be adjusted to individual weighing requirements. The menu is structured as follows

- ⇒ **Application menu:** To adjust the balance to user requirements
- ⇒ **Configuration menu 1:** Definition of the basic functions

7.1. User principle of the menu control

Operation	Display
<p>Switch on balance:</p> 	
<p>Call up menu:</p>  <p>Press for about 4 seconds, until [Func] is displayed.</p>	 <p>When releasing, the first function is displayed [1 SEt 1].</p> 

<p>Changing the function:</p>  <p>Further pressing the keys will call up the various functions of the menu (see table chapter 7.2)</p>	 <p style="text-align: center;">↓</p> 
<p>Changing the parameter:</p>  <p>To change the last digit of the parameter, actuate the TARE-key or the arrow keys.</p>	 <p style="text-align: center;">↓</p> 
<p>Saving your settings:</p>  <p>Leave the function menu and return to weighing mode</p>	

General information about using the arrow keys for entering:





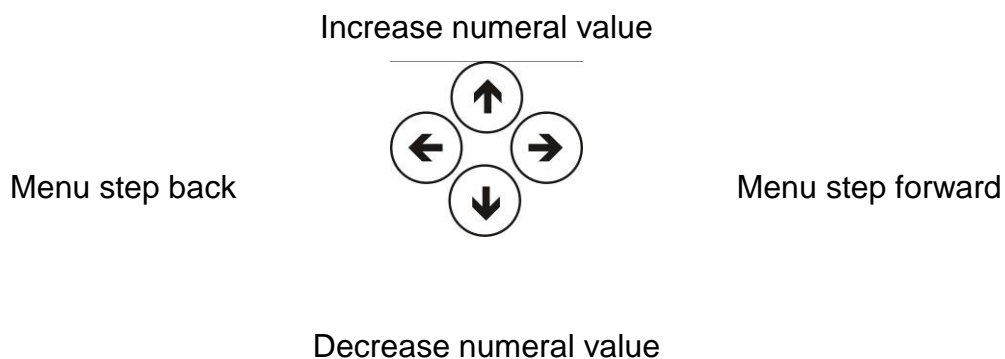

Operation via arrow keys is faster and more comfortable than via the TARE and F key.

Key allocation of the arrow keys:



7.2. Menu overview







The manufacturer's setting has a certain standard configuration. This one is marked with *.

Function		Display  or  	Selection  or  	Description of the options	
Weighing mode		1 SET.	* 1	Weighing	
			2	Parts counting	
			3	Percent determination	
			5	Density determination of solids	
Density determination	Measure medium	11 NEd.	* 0	dest. Water	
			1	Measuring liquid of your selection	
	Data output	12. d.o.d.	* 0	only output measuring value density	
			1	Output of all density parameters	
Autom. Data output	13. A.o.	* 0	OFF (Output only after pressing PRINT key)		
		1	ON		
Additional functions		2 SEL	* 0	Off	
			1	Adding → [2C. Adn.]	
			2	Tolerance weighing	
			3	Combination Tolerance weighing/adding	see chpt. 7.2.1
Zero balancing		3 AD	0	No zero balancing	
			* 1	Automatic zero balancing is activated.	
Vibration filter		4 S.d.	* 2	Sensitive and fast (very quiet set-up location). ↓	
			3	Robust but slow (very busy set-up location)	
			4		
Display speed		5 rE.	0	Setting for dispensing	
			1	Sensitive and fast	
			2	↓	
			* 3	Insensitive but slow	
Interface (see chpt. 7.2.1)		6 IF.	0	Deactivated	
			* 1	6-digit data format	see chap. 14.4.1
			2	7-digit data format	
			3	extended 7-digit data format	not documented

Adjustment * 1: Factory setting PEJ * 3: Factory setting for Class I PES * 4: Factory setting for Class II PES	7. CA.	0	CAL-key deactivated
		* 1	Automatic internal adjustment
		2	Adjustment with external weight
		* 3	External adjustment
		* 4	Adjustment test with external weight
Bar graph	8. bG.	0	Hide bar graph
		* 1	Show bar graph
Automatic turn-off for battery operation (function only exists for battery operation)	9. AP.	0	Automatic turn-off after 3 min. for battery operation (optional) - off.
		* 1	Automatic turn-off after 3 min. for battery operation (optional) - on.
Auto Sleep-Funktion in mains operation	A. AS.	0	Off
		* 1	The balance passes 3 minutes after having been connected to a sleep mode, if there is no load change and no key pressed
Units A	bl. uA	* 1	(g)
		2	(kg)
		4	[ct] (ct)
Units B With this setting you can set different display units (A or B) for one weighing value. Press the F-key to choose between units A and B.	b3. ub	* 0	No unit
		1	(g)
		2	(kg)
		4	[ct] (ct)
Display last fractional digit	C. A.1.	0	no
		* 1	Yes; always use this setting!
In accordance with ISO/GLP/GMP	E. GLP	* 0	no
		1	Yes
only at setting GLP 1	E1. out	0	no
		* 1	Yes
	E2. od.	* 0	no
		1	Yes
	E3. PF.	* 1	English
		2	not documented
Date	F. dAtE	1	Display in year-month-day
		2	Display in month-day-year
		* 3	Display in day-month-year
Time	G. t.o.	* 0	Output - NO
		1	Output - YES
Immediate start	L. dSt.	* 0	When connecting the mains cable, the balance will immediately go into stand-by mode
		1	Balance switches on when plugging in mains power supply
Output interface	n. PrF.	1	not documented
		2	not documented
		* 3	not documented







7.2.1. Parameter additional functions

Not displayed at menu setting „2. SEL 0“

Function	Display  or  	Selection  or  	Description of options
Display conditions of the tolerance marker	21. Co.	*1	Tolerance marker is always displayed, even if standstill control is not yet displayed.
		2	Tolerance marker is only displayed in connection with standstill control.
Tolerance range	22. Li.	0	Tolerance marker is only displayed above zero range (mind +5).
		*1	Tolerance marker is displayed for the whole range.
Number of limiting points	23. Pi	1	1- Limiting point (OK/ -)
		*2	2- Limiting points (+/OK/-)
		3	3- Limiting points (1-4)
		4	4- Limiting points (1-5)
Assessment	24. tYP.	*1	Evaluation for absolute values
		2	Evaluation for difference values (with reference weight)
Signal at limit 1	25. bu1	*0	No signal at limit 1(-)
		1	Signal at limit 1 (-)
Signal at limit 2	26. bu2	*0	No signal at limit 2(Ok)
		1	Signal at limit 2(Ok)
Signal at limit 3	27. bu3	*0	No signal at limit 3(+)
		1	Signal at limit 3(+)
Signal at limit 4	28. bu4	*0	No signal at limit
		1	Signal at limit 4
Signal at limit 5	29. bu5	*0	No signal at limit 5
		1	Signal at limit 5
Display of Results	2A. LG	*1	Display via +, OK or -
		2	For setting 2 limits display in bar graph is possible
Relay output setting	2b r.o.c.	*1	Permanent output, depending external signal
		2	Output controlled by external signal
Add	2C Adn.	*1	Adding function
		2	Adding function with AUTO-TARA

7.2.2. Parameter for serial interface







Not shown for menu setting „6. IF 0“ (interface de-activated).

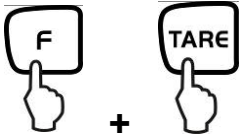

Function	Display  or  	Selection  or  	Description of the options
Output condition at interface	6 1. o.c.	0	No data output
		1	Continuous data output
		2	Continuous data output stable weighing values
		3	Output for stable and instable weighing values after pressing PRINT key
		4	Output for stable weighing value after previous relief of balance
		5	One output for stable weighing value. No output for stable weighing values. Renewed output after stabilization
		6	One output for stable weighing value. Continuous output for instable weighing values.
		* 7	Output of stable weighing values after pressing PRINT key
		A	Single, immediate output after fixed interval (see chpt. 14.5)
		b	Single, immediate output after fixed interval and stable weighing value (see chpt 14.5)
Baud rate	62 b.L.	* 1	1200 bps
		2	2400 bps
		3	4800 bps
		4	9600 bps
		5	19200 bps

Parity only at setting 6 1F. 2 or 6 1F. 3	63 PR.	* 0	No parity bit
		1	Odd parity
		2	Even parity
Data Bits only at setting 6 1F. 3	64 dL.	7	7 bits
		* 8	8 bits
Stop Bits only at setting 6 1F. 3	65 St.	1	1 bit
		* 2	2 bit
not documented	66 u.n.	* 0	Always use this setting
		1	
not documented	67 rES.	* 1	Always use this setting
		2	

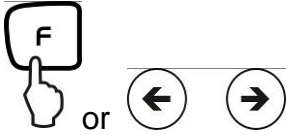
8. Configuration menu 2

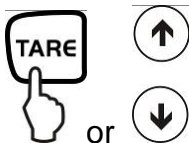
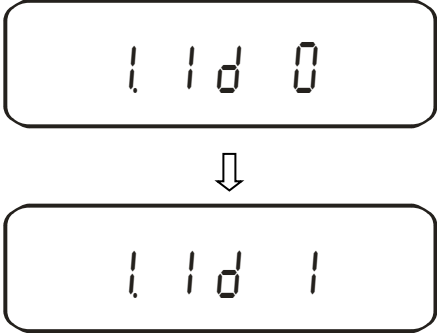

8.1. User principle of the menu control

Operation	Display
<p>Switch on balance:</p> 	
<p>Call up menu:</p>  <p>Hold F-key while TARE key is pressed until [Func 2] is displayed.</p>	 <p>When releasing, the first function is displayed [1. 1 d. 0]</p> 
<p>Changing the function:</p>  <p>Further pressing the keys will take you through the various functions of the menu.</p>	 <p style="text-align: center;">↓</p> 

<p>Changing the parameter:</p>  <p>To change the last digit of the parameter actuate TARE-key or arrow keys.</p>	
<p>Saving your settings:</p>  <p>Leave the menu and return to weighing mode</p>	

8.2. Menu overview

The manufacturer's setting has a certain standard configuration. This one is marked with *.

Function	Display 	Choice 	Description of the options
Setup balance ID no.	1. 1d	*0 1	Off ON
Not documented	2. o.n.P.	*0 1	Always use this setting
Overwriting the adjusting weight Caution: Modifications may only be carried out by specialized personnel!	3. r.CA	*0 1	Off ON
Not documented	4. n.E.H.	*0 1	Always use this setting

9. Operation

9.1. Keyboard overview

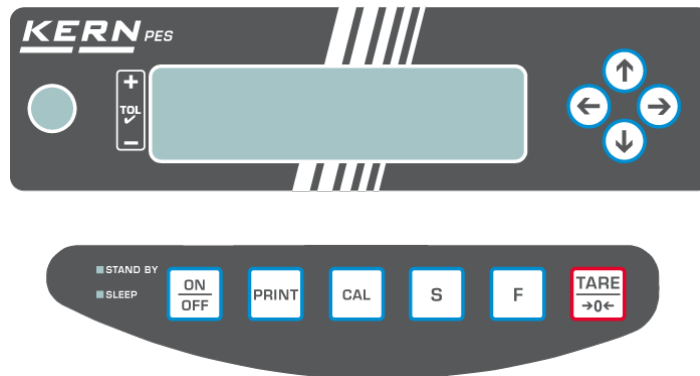

Choice	Function
	<ul style="list-style-type: none"> • Turn on/off
	<ul style="list-style-type: none"> • Output of the weight value on an external device (printer) or PC
	<ul style="list-style-type: none"> • Save function parameters • Addition of displayed values in addition memory • Menu call up "Enter tolerance limits"
	<ul style="list-style-type: none"> • Switching the displayed value (g, ct, Pcs, %) • Entering numeric values • Choosing the function values within the function • Call up individual functions (multiple print) • The entry point will be shifted one spot to the left
	<ul style="list-style-type: none"> • Tare or set weight display to zero • Individual setting within the individual function • Changing the parameters
	<ul style="list-style-type: none"> • Start adjustment /adjustment test
	<ul style="list-style-type: none"> • For many entering functions, the arrow keys replace the or keys (see chapter 7.1)
LED (green)	<ul style="list-style-type: none"> • "Stand-by" glows if the balance is operated with energy from the power mains but turned off.
LED (red)	<ul style="list-style-type: none"> • "Sleep" has the function of a display saver. It can be deactivated by actuating a key or changing the load.

9.2. Overview of display

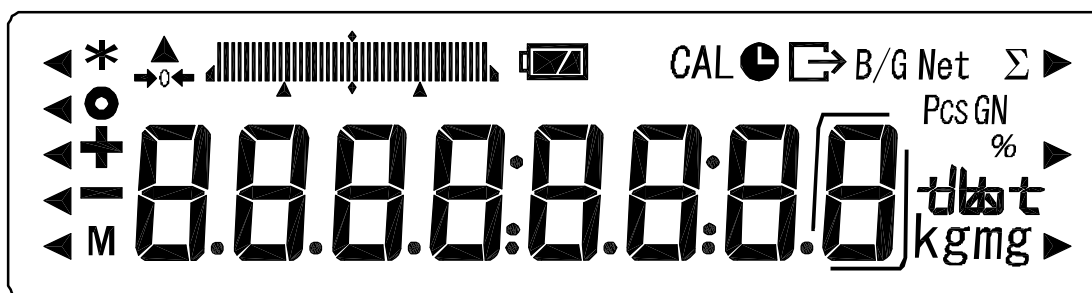

Display	Description
g, kg	Gram, Kilogram
→0←	Zeroing display
-	Minus
o	Stability display
Net	Tara symbol
B/G	Gross weight
Pcs	Parts counting
%	Percent weighing
◀	Tolerance weighing
*	Adding function active
Σ	Total
⌚	Output date/time
M	Balance carries out balance function, e.g. unit count / display of stored value
CAL	Display for adjustment. Signals the adjustment function.
kgmg	Weighing unit display
Bar graph	Bar graph
Battery icon	Message for battery mode (optional) see chpt. 6.6
Small digit icon	Display last fractional digit

10. Weighing mode



This way, 4 different weighing modes are available for you:

1. Weighing [1 5 E t . 1]
2. Weighing/parts counting [1 5 E t . 2]
3. Weighing/percent determination [1 5 E t . 3]
4. Weighing/density determination [1 5 E t . 5]

Excepted weighing / density determination you can activate, with the selection of of a weighing mode, more functions like e.g. tolerance weighing, adding (see chap. 7.2 „Additional functions“). So you can display the measuring values according to your needs.



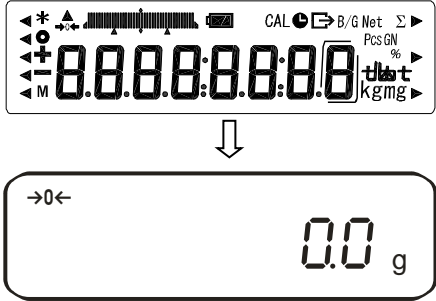



Actuating the  key will switch the displayed value to the active function (e.g. "g" to "Pcs").

10.1. Weighing

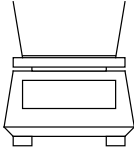

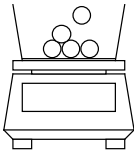

Operation	Display
<p>Switch on balance:</p>  <p>Your balance is ready to weigh as soon as the "0.0" display appears.</p>	<p>The balance will carry out a self-test</p> 
<p>Put on items to be weighed, weighed value is displayed.</p>	
 <p>By repeated pressing, switching option of the displayed value into other activated functions/weighing units</p>	

10.1.1. Taring

The dead weight of any weighing container may be tared away by pressing a button, so that the following weighings show the net weight of the goods to be weighed.

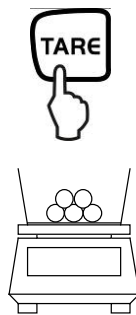
Operation	Display
<p>Place empty tare container on the weighing plate. The total weight of the container is displayed.</p> 	
	<p>Reset display to "0":</p>  <p>The weight of the container is now saved internally; in addition the display shows the tare symbol "Net".</p>
<p>Place the goods to be weighed into the tare container.</p> 	<p>Read the weight of the goods on the display.</p> 

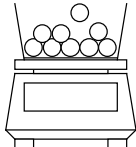
The taring process can be repeated any number of times, e.g. when adding several components for a mixture (adding).

 <p>The diagram shows a hand with the index finger pointing at a button labeled 'TARE'. Below the hand is a balance scale with a weighing pan containing three small circles representing components.</p>	<p>Reset display to "0":</p>  <p>The digital display shows '0.0' with 'g' below it and 'Net' above it.</p> <p>The total weight of the container is tared away.</p>
<p>Add more components into the weighing container (adding).</p>  <p>The diagram shows a balance scale with a weighing pan containing six small circles representing components.</p> <p>Now read off the weight of the added item to be weighed on the display.</p>	 <p>The digital display shows '4570.9' with 'g' below it and 'Net' above it.</p>









NOTE:

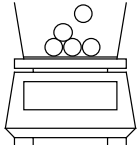

The balance is able to only store one taring value at a time.
When the balance is unloaded the saved taring value is displayed with negative sign.
Remove all items from the weighing plate in order to delete the stored tare value and subsequently press the TARE key.
The taring process can be repeated any number of times. The limit is reached when the whole weighing range is exhausted.

10.1.2. Net/gross

The dead weight of any weighing container may be tared away by pressing a button. For subsequent weighings the net weight of the goods to be weighed as well as the gross weight goods + taring container can be displayed.

Condition: * Function [! 5E.L. !] active (see chapter 7)

Operation	Display
<p>Place empty tare container on the weighing plate. The total weight of the container is displayed.</p> 	
	<p>Reset display to "0":</p>  <p>The weight of the container is internally stored, the display shows the tare symbol "Net".</p>
<p>Place the goods to be weighed into the tare container.</p> 	<p>The net weight of the goods to be weighed is displayed.</p> 
	<p>The gross weight (goods + taring container) is displayed, the display shows the gross symbol "B/G".</p> 



 <p>Use the F key to switch from net weight to gross weight or vice versa</p> <p>This procedure may be repeated any number of times (max. weighing range of the balance).</p>	
--	--





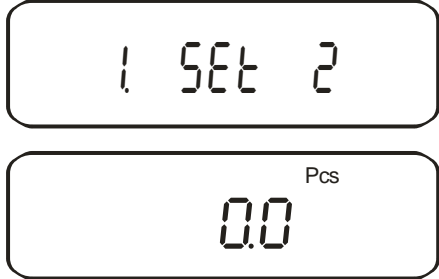

10.2. Parts counting

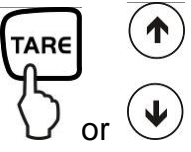
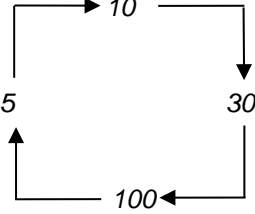
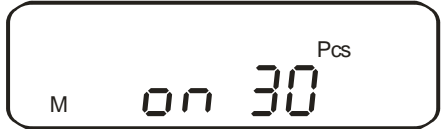

With parts counting you can either count parts into a container or remove parts from a container. To count a greater number of parts the average weight per part has to be determined with a small quantity (reference quantity). The larger the reference quantity, the higher the counting exactness. High reference must be selected for small parts or parts with considerably different sizes.

The process has four steps:

- Tare the weighing container
- Determine the reference unit
- Weigh in the reference unit
- Count the items

Operation	Display
<p>Activate function [1 SEt. 2] (see chapter 7).</p> <p>The display shows the piece counting symbol "Pcs".</p>	
 <p>If you are using a weighing container</p>	

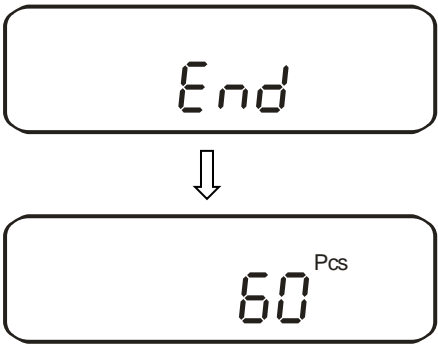
<p>Determine the reference unit:</p>  <p>Press for about 4 seconds until [U. Set.] appears, then release</p>	<p>The display shows flashing the last saved reference quantity.</p>  <p>The display e.g. 10 Pcs. prompts you to enter 10 pieces as reference.</p>
<p>Change reference quantity:</p>  <p>Use the TARE-key or the arrow keys to switch between the following reference quantities:</p>  <p>Important: The larger the reference quantity, the more accurate the parts counting.</p>	
<p>Weigh in the reference unit:</p> <p>Place as many parts to count on the balance as the set reference quantity requires.</p> 	<p>The reference quantity is displayed flashing.</p>  <p>The balance offers the possibility of reference optimisation. If you do not want this, press F key.</p>
<p>By adding more pieces (up to the 3-fold quantity), you can optimise the reference. At every reference optimisation, the reference weight is calculated anew. As the additional pieces increase the base for the calculation, the reference also becomes more exact.</p>	

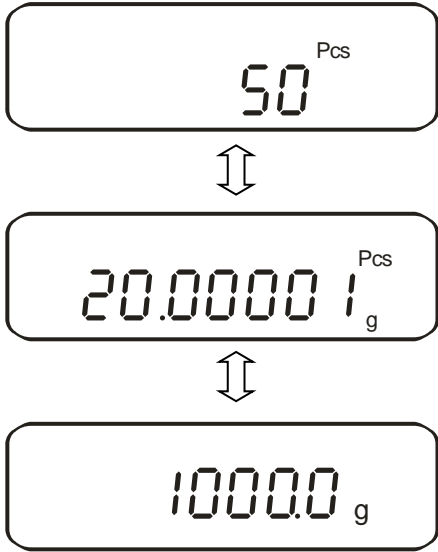
 <p>The reference weight is saved. Remove reference weight.</p>	
<p>Count the items:</p> <p>Now you can fill the items to be counted into the container. The respective quantity is shown in the display.</p>	
 <p>By repeated pressing, switching option of the displayed value of the displayed value e.g. in:</p> <ul style="list-style-type: none"> • Number of parts placed on balance "Pcs" <p style="text-align: center;">⇕</p> <ul style="list-style-type: none"> • Average part weight "g/Pcs" <p style="text-align: center;">⇕</p> <ul style="list-style-type: none"> • Weight of parts placed on balance in "g" 	





NOTE:



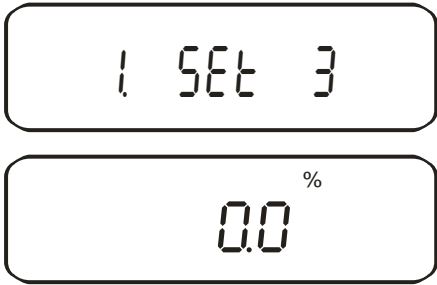

- If the error message „**Sub**“ appears, in the reference optimisation the triple quantity has been exceeded
- If the error message “**L-Err**“ appears the smallest counting weight has not been reached.
- If the “**Add**“ error message appears, the applied number of items is too small for correct determination of the reference. For reference, place more parts on the balance.

10.3. Percent determination

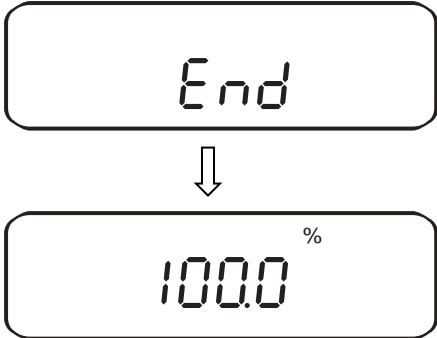
Percent weighing allows to display weight in percent, in relation to a reference weight. The displayed weighing value is stored as a standard percent value (default setting: 100%).

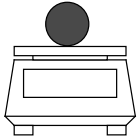
10.3.1. Entering the reference weight by weighing



Operation	Display
<p>Activate function [1 5 E t 3] (see chap. 7).</p> <p>The display shows the %-symbol.</p>	
<p>Determine reference weight:</p>  <p>Press for about 4 seconds, until [P. 5 E t] is displayed, then release</p>	<p>The display shows flashing the last saved reference weight</p>
<p>Put on reference weight (=100 %)</p> 	
 <p>An acoustic signal sounds; the reference weight is saved.</p> <p>Remove reference weight.</p>	





<p>From now, the added weight is shown in %.</p> 	
 <p>By repeated pressing, switching option of the displayed value in „g“ or %“</p>	 <p style="text-align: center;">↕</p> 

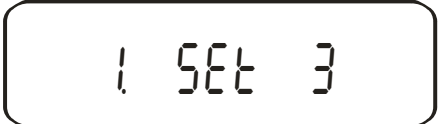



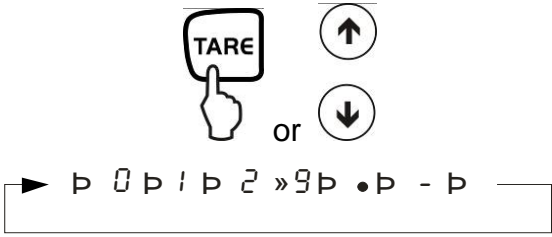
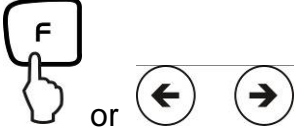

NOTE:

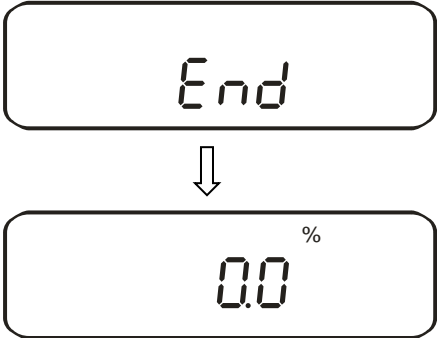
- If the error message “**o-Err**“ is displayed, the reference weight is outside the weighing range
- The 100% reference is preserved until the balance is disconnected from the mains.

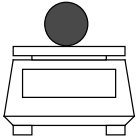
10.3.2. Numeric entering of the reference weight

Operation	Display
<p>Activate function [1 5Et 3] (see chap. 7).</p> <p>The display shows the %-symbol.</p>	 
<p>Determine reference weight:</p>  <p>Press for about 4 seconds, until [P. 5Et] is displayed, then release</p>	<p>The display shows flashing the last saved reference weight</p>

	 <p>With "0" flashing, you are prompted to enter the reference weight numerically</p>
<p>Entering the numeric value:</p>  <p>Any time you press TARE-key or the arrow key, you will go through the numbers 0-9, decimal dot and minus</p>	
<p>Select the number to be changed (the active position flashes):</p> 	
 <p>An acoustic signal sounds; the entered reference weight is saved</p>	







<p>From now, the added weight is shown in %.</p> 	
<p>By repeated pressing, switching option of the displayed value in „g“ or %“</p> 	  



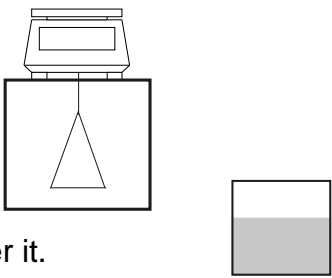

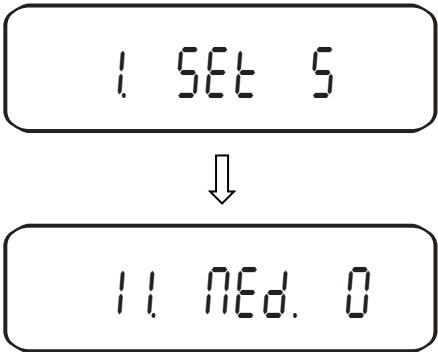
NOTE:

- If the error message “**o-Err**” is displayed, the reference weight is outside the weighing range
- The 100% reference is preserved until the balance is disconnected from the mains.



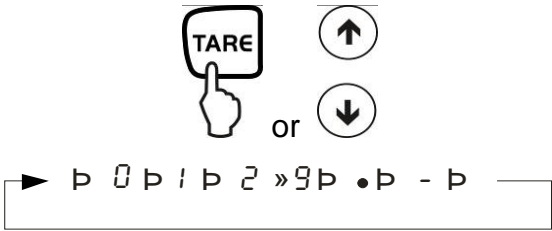
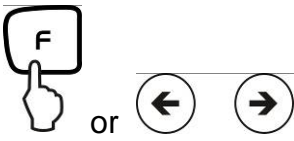

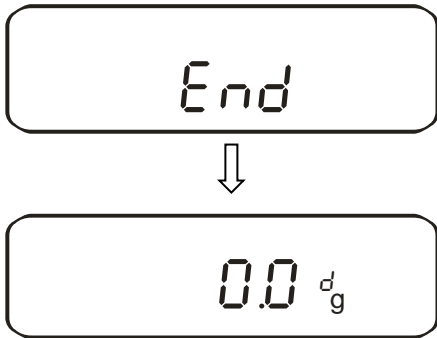

10.4. Density determination of solids (hydrostatic weighing)



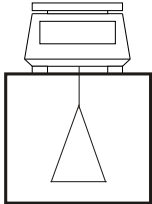

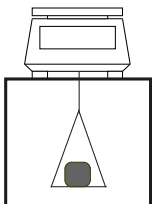
Density is the relationship of weight [g] : volume [cm³]. The weight is determined by weighing the sample in air. The volume results from the ascending force [g] of the sample dipped in a liquid. The density [g/cm³] of that liquid is known (principle of Archimedes).

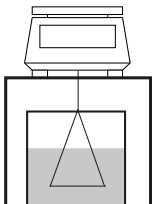
Operation	Display
<p>The density is determined with help of the underfloor weighing device. Prepare the balance as follows:</p> <ul style="list-style-type: none"> • Turn-over the balance • Screw-in hook for underfloor weighing (option) • Put the balance over an opening • Hook-in the sample support • Fill measuring liquid in a vessel (e.g. beaker) and temper it. 	
<p>Activate function [! 5Et 5] (see chap. 7).</p>  <p>Selecting measuring liquid</p> <p>[0] : dest. Wasser</p> <p>[!] : Measuring liquid of your selection, density of which is known</p>	
	
<p>If you selected distilled water [! ! nEd. 0] the water temperature is input (input range 0.0 to 99.9°).</p>	
 <p>Press and keep pressed until the blinking display appears</p>	

<p>Input of temperature:</p>  <p>Any time you press TARE-key or the arrow key, you will go through the numbers 0-9, decimal dot and minus</p>	
<p>Select the number to be changed (the active position flashes):</p> 	
 <p>Save, an acoustic signal sounds</p>	
<p>Once you have selected a measuring liquid according to your selection [1 NEd.] its density is input (input range 0.0001 to 9.9999 g/cm³).</p>	
 <p>Press and keep pressed until the blinking display appears</p>	 <p>Density is input via the TARE and F key, saving via the S key (see temperature input)</p>

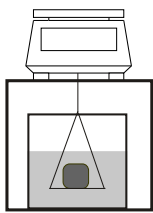
After the parameter input for the measuring liquid, the density of your sample will be determined

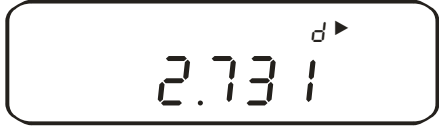





<p>1. Weight of the sample in air</p>   <p>Tare balance with sample holder</p>	
<p>Put-on sample</p>  <p>Wait till the weight display on the balance is stable</p>  <p>The weight of the sample in air is saved</p>	
<p>2. Sample weight in the measuring liquid</p>   <p>Immerse and tare the sample holder</p>	





<p>Place sample and immerse it</p>  <p>Wait till the weight display on the balance is stable</p>  <p>The weight of the sample in the measuring liquid is saved</p>	 <p>↓</p>  <p>The density of your sample is displayed, characterized by the ► symbol right above.</p>
 <p>Return to density determining mode</p>	

11. Adding of displayed values

Any number or individual weighings are automatically added to a total, e.g. all individual weighings of a batch.

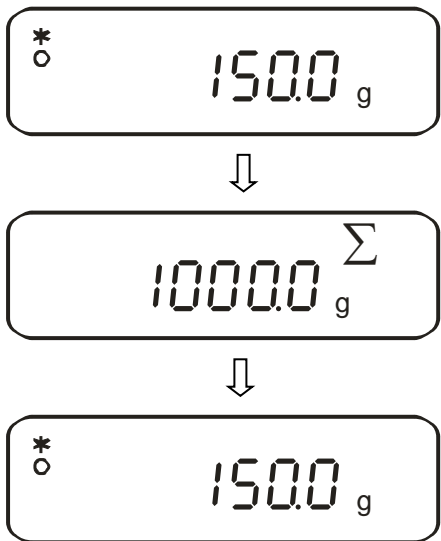
The adding function is possible in all functions of the weighing mode (Weighing/parts counting/ percent determination).

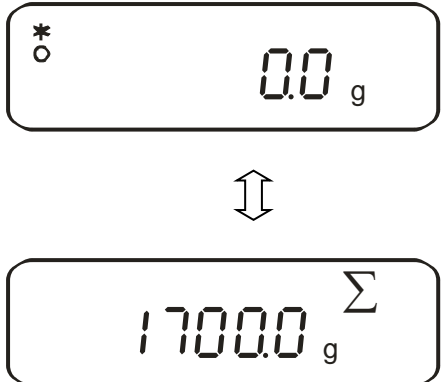
Operation	Display
<p>1. Activate function [2 SEL 1] (see chap. 7).</p>  <p>2. Select one of the following settings [1]: Add [2]: Adding with AUTO-TARA</p>	 <p style="text-align: center;">↓</p> 
<p>3. Place the weight A, wait until the stability display [O] appears</p>	
 <p>4. The displayed value is added into the total adding memory. The total [Σ] is briefly shown</p>	
<p>5. Remove weight.</p>	
<p>6. Wait until the balance zero display is shown, then place weight B on balance</p>	

<p>7. Wait until stability display is shown [O]:</p>  <p>The displayed value is added into the total adding memory. The total [Σ] is briefly shown</p>	
<p>Remove weight and place further weights on balance; for each weight, repeat step 4 to 6</p>	
<p>8. Total of all individual weighings:</p>  <p>By repeatedly pressing the F-key, switching of the displayed value into other activated functions.</p>	
<p>9. Delete total added memory: Display total (step 7), then press TARE-key.</p> 	

11.1. Adding with AUTO-TARE

Adding of displayed values is possible without removing the weight.

Condition: Function [2]. *Ад.П. 2*] activated

To be carried-out like the normal adding (see chap. 11).

Hereby omit step 4. The balance is automatically reset to zero, without taking away the weight.

12. Weighing with tolerance range

12.1. General Information

This balance can be used as dispensing as well as sorting balance; the respective lower tolerance limit as well as upper tolerance limit can be programmed. An acoustic signal supports portioning, dispensing or sorting.

In the menu, (see chapter 7) activate the tolerance weighing function:

[2.5EL.2]

or the combination tolerance weighing/adding (tolerance control on the respective poured quantity):

[2.5EL.3]

Entering limits is possible for the following functions:

- Weighing
- Parts counting
- Percent determination
- Weighing with freely programmable weighing unit

There are two different ways to carry out evaluation of limits:

1. Evaluation of absolute values **[24. tYP.1]**:
An exact reference value (e.g. 1 kg) is set.
2. Evaluation with difference values **[24. tYP.2]**:
An upper limit and a lower limit for a reference value are set.

Example:

	Reference value	Lower limit	Upper limit
Poured quantity	1,000.0 g	970.0 g	1,050.0 g
Evaluation of absolute values	1,000.0 g	970.0 g	1,050.0 g
Evaluation with difference values	1,000.0 g	-30.0 g	50.0 g

There are two different ways to set the tolerance limits:

1. Place the values (object) on the balance -
 > Save this value
2. Numeric entering of values -
 > Enter the limits via keyboard.

NOTE:

- ⇒ If a limiting value was set it remains saved until the balance is turned off.
- ⇒ For the functions weighing, counting, percent individual limits can be set.
- ⇒ When entering the limits please pay attention to the type of evaluation that was set.

12.2. Display of the results

12.2.1. For 2 limits

The triangular tolerance marker (◀) in the upper part of the display shows whether the goods to be weighed are within the two tolerance limits. The tolerance marker is only in operation during operating mode tolerance weighing; it is otherwise not visible.

The tolerance marker provides the following information:



Goods to be weighed above tolerance limit



Goods to be weighed within tolerance range

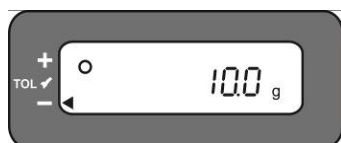

Goods to be weighed below tolerance limit

Display Result	If a point is set as lower limit	If two points are set as upper and lower limit
+ (high)	No display	Weight > Upper limit
TOL ✓ (OK)	Lower limit ≤ Weight	Lower limit ≤ Weight ≤ Upper limit
- (low)	Lower limit > Weight	Lower limit > Weight

12.2.2. For 3 or 4 limits

Display of tolerance mark

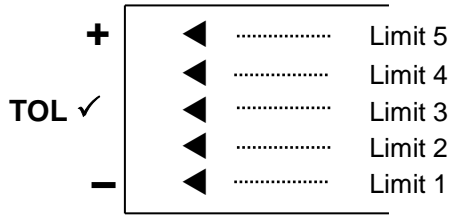

Limit 5	4. Limit point \leq Weight
Limit 4	3. Limit point \leq Weight < 4. Limit point
Limit 3	2. Limit point \leq Weight < 3. Limit point
Limit 2	1. Limit point \leq Weight < 2. Limit point
Limit 1	Weight < 1. Limit point

12.3. Basic settings for weighings with tolerance range







Operation	Display
<p>1. Activate tolerance weighing function [2.5EL.2] or [2.5EL.3] (see chap. 7).</p>	<p style="text-align: center;">↓</p>
<p>2. Selection of tolerance parameters</p> <p>Any time you press the F-key you can select between the following settings, see chap. 7.2.1</p>	<p>The first parameter for setting the tolerance marker appears.</p>
<p>3. Changing the parameter value</p>	<p style="text-align: center;">↓</p>



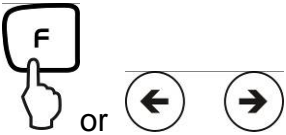

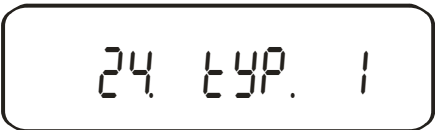

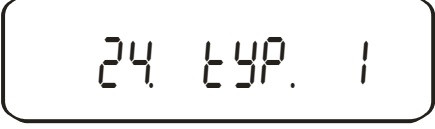
12.4. Evaluation of absolute values

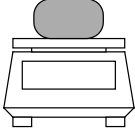

12.4.1. Entering 2 limits by weighing

Important information!

Always begin by entering the lower limit value, followed by the upper limit value. Enter.



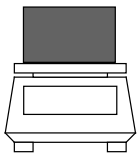

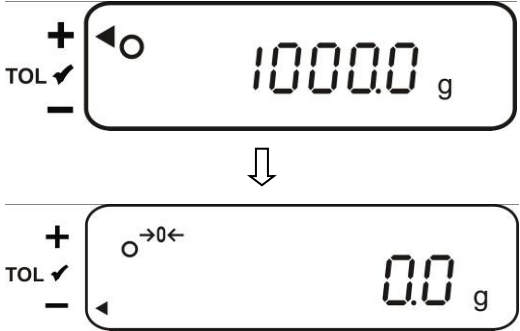



Operation	Display
<p>1. Activate tolerance weighing function [2.5EL.2] or [2.5EL.3] (see chap. 7).</p>	 <p style="text-align: center;">↓</p>
<p>2. Actuate required parameter selection</p>  <p style="text-align: center;">or</p>  <p style="text-align: center;">or</p>  <p style="text-align: center;">until</p> <p>[23. P1.1] or [24. tYP.1] is displayed;</p> <p>more settings of your choice (see chap. 12.3) are carried out in an analogue manner</p>	 <p style="text-align: center;">↓</p> <p>Parameter selection for 2 limiting points:</p>  <p>Parameter selection for absolute value:</p> 
<p>3. Leave function menu</p> 	 <p>The balance is now in tolerance weighing mode; the tolerance marker (◀) appears</p>



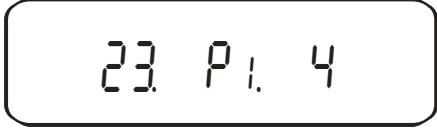
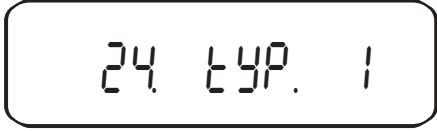

<p>4. Entering limiting values:</p>  <p>Press for about 4 seconds, until [L. SEt] is displayed, then release</p>	  <p>The flashing display (last saved value) prompts you to enter the lower limiting value (L. SEt)</p>
<p>5. Place sample for the lower (i.e. smaller) limiting value on the weighing plate:</p> 	
<p>6. Save:</p> 	<p>An acoustic signal sounds, the saved lower limit is briefly displayed.*</p>    <p>The flashing display (last saved value) prompts you to enter the upper limiting value (H. SEt)</p>

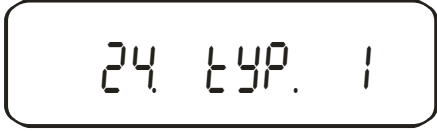

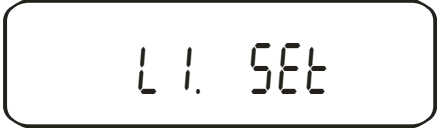

<p>7. Place sample for the upper (i.e. larger) limiting value on the weighing plate:</p> 	
<p>8. Save:</p>  <p>The balance returns to tolerance weighing mode. From here evaluation takes place whether the goods to be weighed are within the two tolerance limits.</p>	<p>An acoustic signal sounds, the saved upper limit is briefly displayed.</p> 

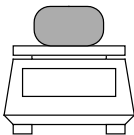
* If you want to set for your tolerance weighing only one limit point (parameter selection [23. P 1. 1]), ignore step 7 and 8.

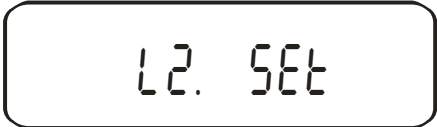
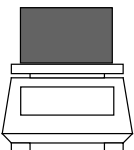
12.4.2. Entering 3 or 4 limits by weighing

Operation	Display
<p>1. Activate tolerance weighing function [2.5EL.2] or [2.5EL.3] (see chap. 7).</p>	 <p style="text-align: center;">↓</p>
<p>2. Actuate required parameter selection</p>  <p style="text-align: center;">or</p>  <p style="text-align: center;">or</p>  <p style="text-align: center;">until</p> <p>[23. P1.1] or [24. tYP.1] is displayed;</p> <p>more settings of your choice (see chap. 12.3) are carried out in the same way</p>	 <p style="text-align: center;">↓</p> <p>Parameter selection for 3 limiting points:</p>  <p>Parameter selection for 4 limiting points:</p>  <p>Parameter selection for absolute value:</p> 
<p>3. Leave function menu</p> 	









<p>4. Entering limiting values:</p>  <p>Press for about 4 seconds, until [L 1 .5E6] is displayed, then release</p>	 <p style="text-align: center;">↓</p>  <p>The flashing display (last saved value) prompts you to enter the first lower limiting value (L1 .5E6)</p>
<p>5. Place sample for the first limiting value on the weighing plate:</p> 	
<p>6. Save:</p> 	<p>An acoustic signal sounds, the saved first limiting value is briefly displayed.*</p>  <p style="text-align: center;">↓</p>  <p>The flashing display (last saved value) prompts you to enter the second limiting value (L 2.5E6)</p>
<p>7. Place sample for the second limiting value on the weighing plate:</p> 	

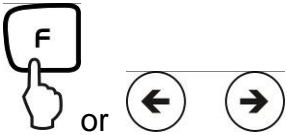

<p>8. Save:</p> 	<p>An acoustic signal sounds, the saved second weighing value is briefly displayed.</p> <p style="text-align: center;">↓</p>  <p>The flashing display (last saved value) prompts you to enter the third limiting value (L 3.5Et)</p>
<p>9. To enter 3rd and 4th limiting value, repeat steps 7 and 8</p>	
<p>10. Save:</p>  <p>The balance returns to tolerance weighing mode. From here, evaluation is carried out whether the goods to weighed are within the tolerance limits.</p>	<p>An acoustic signal sounds, the last saved 3rd or 4th limiting value is briefly displayed.</p> 

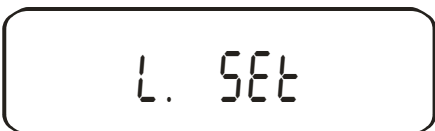

Display of tolerance mark

<p>TOL ✓</p>	+	◀	[L 4.5Et]	4. limit point
		◀	[L 3.5Et]	3. limit point
	-	◀	[L 2.5Et]	2. limit point
		◀	[L 1.5Et]	1. limit point

12.4.3. Numeric entering of 2 limits

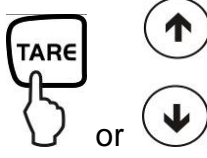
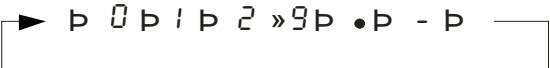
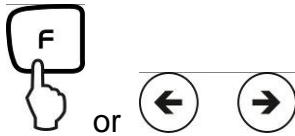
Operation	Display
<p>1. Activate tolerance weighing function [2.5EL.2] or [2.5EL.3] (see chap. 7).</p>	 <p style="text-align: center;">↓</p>
<p>2. Actuate required parameter selection</p>  <p style="text-align: center;">or ← →</p> <p style="text-align: center;">until</p> <p>[23. P1.1] or [24. tYP.1] is displayed;</p> <p>more settings of your choice (see chap. 12.3) are carried out in the same way</p>	 <p style="text-align: center;">↓</p> <p>Parameter selection for 2 limiting points:</p>  <p>Parameter selection for absolute value:</p> 
<p>3. Leave function menu</p> 	 <p>The balance is now in tolerance weighing mode; the tolerance marker (◀) appears</p>
<p>4. Entering limiting values:</p>  <p>Press for about 4 seconds, until [L. 5EL] is displayed, then release</p>	 <p style="text-align: center;">↓</p>  <p>The last saved limiting value is displayed flashing</p>

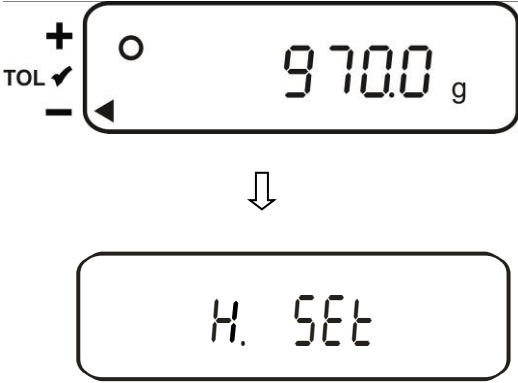
<p>5.</p> 	<p>Display changes to flashing "zero"</p>  <p>The flashing display prompts you to numerically enter the lower limit</p>
<p>6. Entering numeric value for the lower limit</p>   <p>Any time you press the TARE-key or the arrow keys you will go through the numbers 0-9, decimal dot and minus</p>	
<p>Select the number to be changed (the respective active position flashes)</p> 	

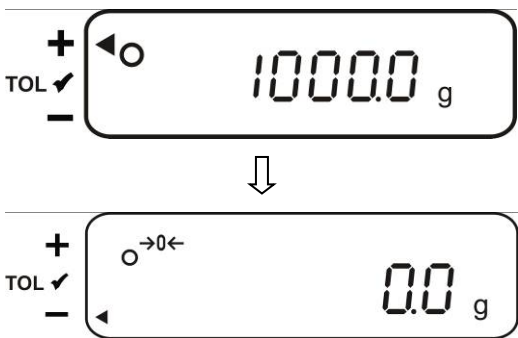
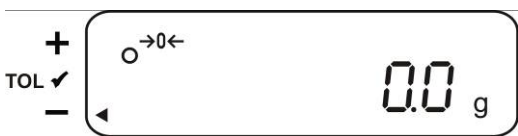
<p>7. Save:</p> 	<p>An acoustic signal sounds, the saved lower weighing value is briefly displayed.</p>  <p>The flashing display (last saved value) prompts you to enter the upper limiting value</p>
<p>8. To enter the numeric value for the upper limiting value, repeat steps 5 - 6</p>	
<p>9. Save:</p>  <p>The balance returns to tolerance weighing mode. From here evaluation takes place whether the goods to be weighed are within the two tolerance limits.</p>	<p>An acoustic signal sounds, the saved upper limit is briefly displayed.</p>  





To enter 3 or 4 limiting values [L 1 SEt] - [L 3 SEt] or [L 4 SEt], repeat steps 5 to 7 (see also chapter 12.4.2).



12.5. Evaluation with difference values

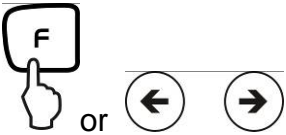

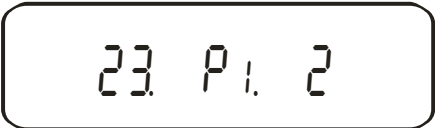
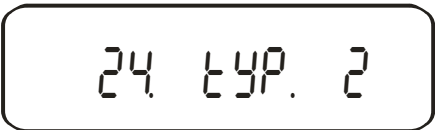

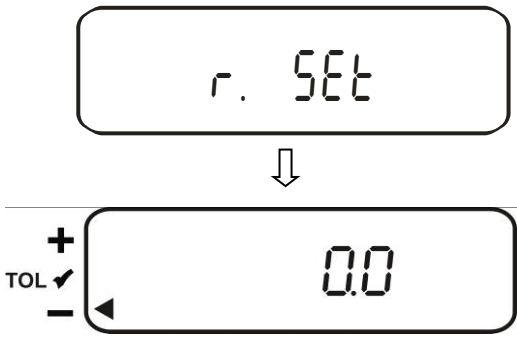
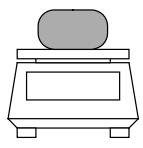

12.5.1. Entering 2 limits by weighing

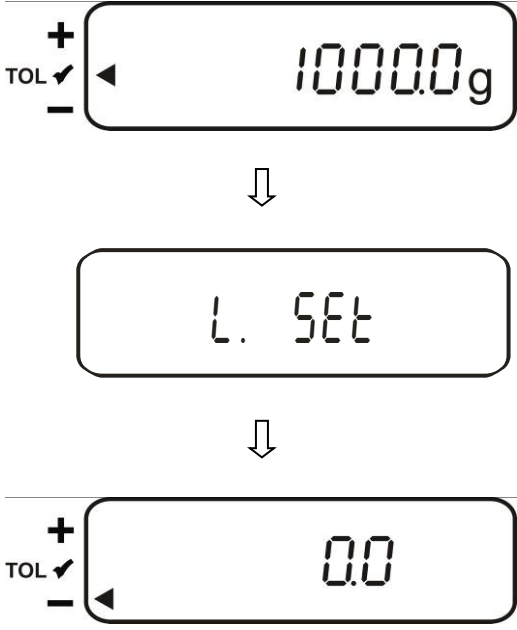
Important information!

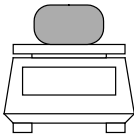
Always begin by entering the lower limit value, followed by the upper limit value. Enter.

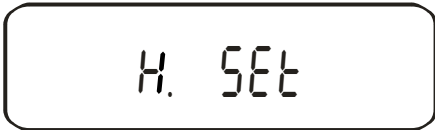
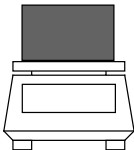
Operation	Display
<p>1. Tolerance weighing function [2.5EL.2] or [2.5EL.3] (see chapter 7).</p>	 <p style="text-align: center;">↓</p>
<p>2. Actuate required parameter selection</p>  <p style="text-align: center;">or</p> <p style="text-align: center;">until</p> <p>[23. P1.2] or [24. tYP.2] appears; more settings of your choice (see chap. 12.3) are carried out in the same way</p>	 <p style="text-align: center;">↓</p> <p>Parameter selection for 2 limiting points:</p>  <p>Parameter selection for difference value:</p> 
<p>3. Leave function menu</p> 	 <p>The balance is now in tolerance weighing mode; the tolerance marker (◀) appears</p>

<p>4. Entering a reference value:</p>  <p>Press for about 4 seconds, until [r.5Et] appears, then release.</p>	 <p>The flashing display (last saved value) prompts you to enter a reference value</p>
<p>5. Place reference weight onto weighing plate:</p> 	
<p>6. Save</p> 	<p>An acoustic signal sounds, the saved reference value is briefly displayed.*</p>  <p>The flashing display (last saved value) prompts you to enter the lower limiting value</p>

<p>7. Place sample for the first limiting value on the weighing plate:</p> 	
<p>8. Save</p> 	<p>An acoustic signal sounds, the saved lower difference value is briefly displayed.</p>   <p>The flashing display (last saved value) prompts you to enter the upper limiting value</p>
<p>9. Place sample for the upper (i.e. larger) limiting value on the weighing plate:</p> 	
<p>10. Save</p>  <p>Remove sample from weighing plate. The balance returns to tolerance weighing mode. From here evaluation takes place whether the goods to be weighed are within the two tolerance limits.</p>	<p>An acoustic signal sounds, the saved upper difference value is briefly displayed.</p>   

* If you want to set for your tolerance weighing only one limit point (parameter selection [23. P 1. 1]), the input herewith is finished.









12.5.2. Entering 3 or 4 limits by weighing



To enter 3 or 4 limiting values [L 1 5Et] - [L 3 5Et] or [L 4 5Et], repeat steps 7 and 8 (see also chapter 12.4.2).



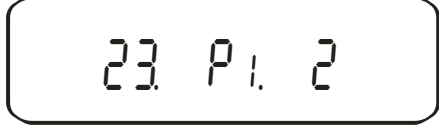
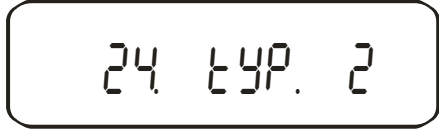



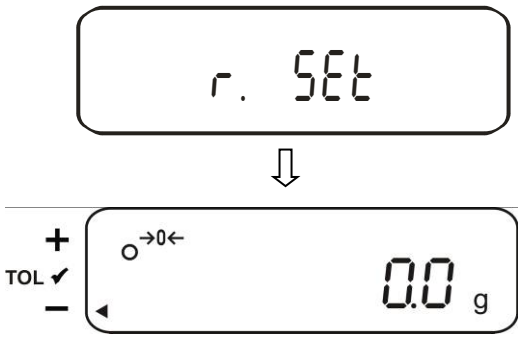

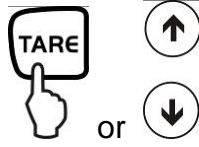
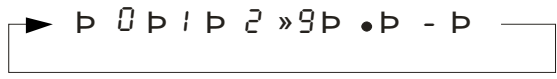
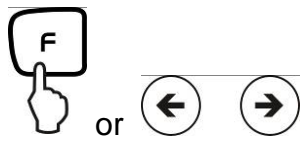
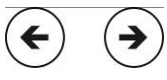
Display of tolerance mark

TOL ✓	+	◀ [L 4.5Et]	4. limiting point
		◀ [L 3.5Et]	3. limiting point
		◀ [r.5Et]	Reference weight
		◀ [L 2.5Et]	2. limiting point
	-	◀ [L 1.5Et]	1. limiting point

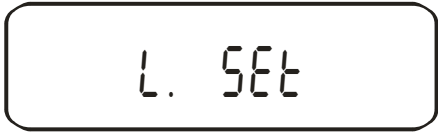
12.5.3. Numeric entering of 2 limits

Operation	Display
<p>1. Activate tolerance weighing function [2.5EL.2] or [2.5EL.3] (see chap. 7).</p>	
<p>2. Actuate required parameter selection</p> <div style="text-align: center;">  or   </div> <p>until</p> <p>[23. P1.2] or [24. tYP.2] appears; more settings of your choice (see chap. 12.3) are carried out in the same way</p>	  Parameter selection for 2 limiting points:  Parameter selection for difference value: 
<p>3. Leave function menu</p> <div style="text-align: center;">  </div>	 The balance is now in tolerance weighing mode; the tolerance marker (◀) appears

<p>4. Entering a reference value:</p>  <p>Press for about 4 seconds, until [r.5Et] appears, then release.</p>	 <p>The last saved reference weight appears flashing</p>
<p>5.</p> 	<p>Display changes to flashing "zero"</p>  <p>The flashing display prompts you to numerically enter a reference weight</p>
<p>6. Entering a numeric value</p>  <p>or</p>  <p>Any time you press TARE-key or the arrow key, you will go through the numbers 0-9, decimal dot and minus</p>	
<p>Select the number to be changed (the respective active position flashes)</p>  <p>or</p> 	

<p>7. Confirm</p> 	<p>An acoustic signal sounds, the saved reference weight is briefly displayed.</p>  <p style="text-align: center;">↓</p>  <p>The flashing display (last saved value) prompts you to enter the lower difference value</p>
<p>8. Entering lower limit Repeat steps 5 and 6</p>	
<p>9. Confirm</p>  <p>10.</p>	<p>An acoustic signal sounds, the saved lower difference value is briefly displayed.</p>  <p style="text-align: center;">↓</p>  <p>The flashing display (last saved value) prompts you to enter the upper difference value</p>
<p>11. Entering upper limit Repeat steps 5 and 6</p>	

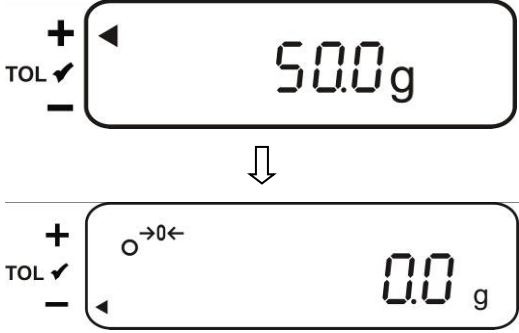
<p>11. Save</p>  <p>The balance returns to tolerance weighing mode. From here evaluation takes place whether the goods to be weighed are within the two tolerance limits.</p>	<p>An acoustic signal sounds, the saved upper difference value is briefly displayed.</p> 
--	---









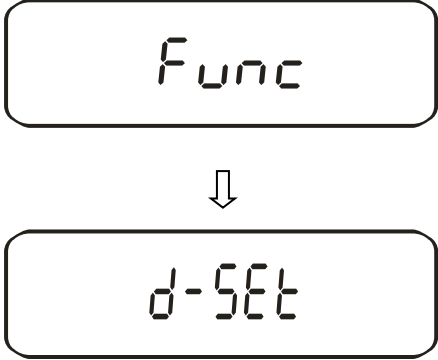



To enter 3 or 4 limiting values [L 1 SEt] - [L 3 SEt] or [L 4 SEt], repeat steps 8 and 9 (see also chapter 12.4.2).

13. Setting date and time

Display symbol []

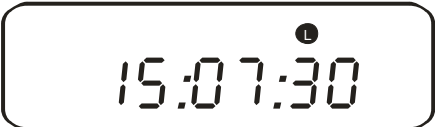
13.1. Time









Operation	Display
<p>1. Call up menu</p>  <p>Keep pressed until [d-SEt] appears.</p>	



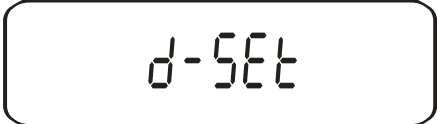

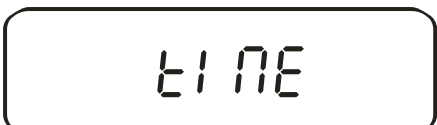
 <p>Press again</p>	 <p style="text-align: center;">↓</p>  <p>Last stored time appears.*</p>
<p>2. Resetting time</p> 	 <p>Time to be changed is flashing</p>
<p>Select the number to be changed (the active position flashes):</p> 	
<p>Changing the numerical value</p> 	
<p>3. Save</p> 	<p>After storing your setting, the date display will appear</p> 
<p>4. Return to weighing mode</p> 	

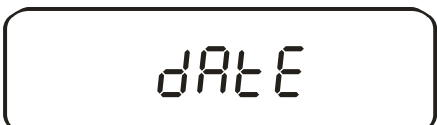
*Notice: The display can be rounded up (from 30 s) or down (to 29 s) by pressing the TARE-key.

13.2. Date

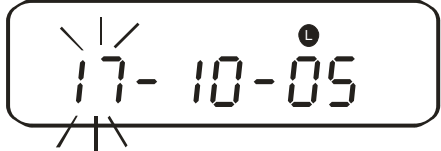
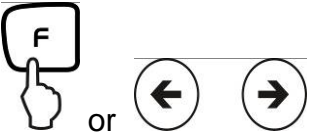
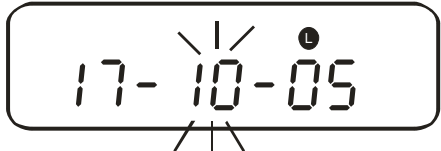
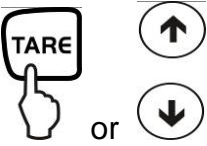
You can set the display of your data output under menu item *F. dAtE* (see menu overview chpt. 7.2.).







Operation	Display
<p>1. Call up menu</p>  <p>Keep pressed until [d-SEt] appears.</p>	 <p style="text-align: center;">↓</p> 
 <p>Press again</p>	 <p style="text-align: center;">↓</p>  <p>Last stored time appears</p>
 <p>Press again</p>	 <p style="text-align: center;">↓</p>  <p>Last stored date</p>

<p>2. Resetting the date</p> 	 <p>Time to be changed is flashing</p>
<p>Select the number to be changed (the active position flashes):</p> 	
<p>Changing the numerical value</p> 	
<p>3. Save</p> 	<p>After storing your settings, the balance will automatically return to weighing mode.</p> 

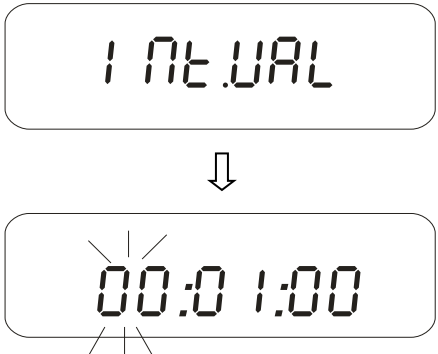
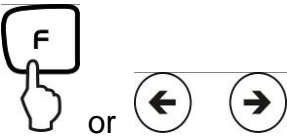

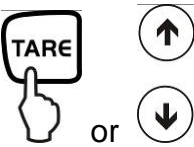



13.3. Interval output function

This menu item allows you to determine after which interval you wish data output to be carried out. To achieve this, activate the [\bar{S} I. o. c A] or [\bar{S} I. o. c b] function in the menu (see chpt. 7.2.1)

13.3.1. Interval setting

Operation	Display
<p>1. Call up menu</p>  <p>keep pressed until [I N T E R V A L] appears.</p>	 <p>Time to be changed is flashing</p>
<p>2. Set interval</p> <p>Select the number to be changed (the active position flashes):</p> 	
<p>Changing the numerical value</p> 	
<p>3. Save:</p> 	<p>After storing your settings, the balance will automatically return to weighing mode.</p> 







13.3.2. Start/Stop interval output



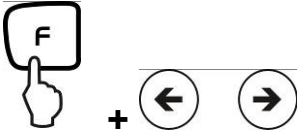

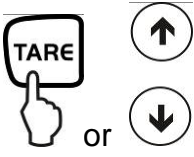

Operation	Display
 <p>Start output</p>	 <p style="text-align: center;">↓</p> 
 <p>Stop output</p>	 <p style="text-align: center;">↓</p>  <p>The balance returns automatically into weighing mode.</p>

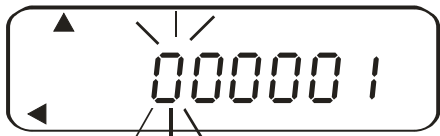
13.4. Input balance ID-no.

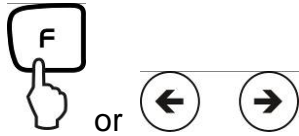
Display symbol [◀] and [▲]

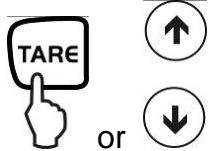
You can enter a 6-digit number using the characters [0-9], [A-F] and [-]. Space character is displayed as [_].

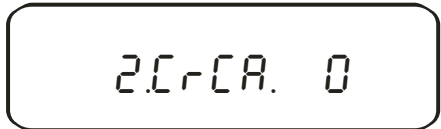
Operation	Display
<p>1. Call up menu</p>  <p>Hold F-key while TARE –key is pressed until [Func 2] is displayed. see chapter 8.</p>	 <p>When releasing, the first function is displayed [1 d 0]</p> 
<p>2. Activate function</p> 	
<p>3. Display ID nr.</p> 	 <p>The last stored number appears</p>
<p>4. Input ID nr.</p> 	 <p>Time to be changed is flashing</p>

<p>Select the number to be changed (the active position flashes):</p> 	
<p>Changing the numerical value</p> 	
<p>5. Save:</p> 	<p>Your setting will be stored and the next menu item will appear.</p> 
<p>6. Return to weighing mode</p> 	

14. Data output

The regular equipment of the balance includes an RS 232C interface and a printer interface.

14.1. RS 232C interface

The RS 232C interface allows a bi-directional data exchange from the balance to external devices. This data exchange is asynchronous using ASCII - Code.

Pin allocation of balance output plug:

Pin nr.	Signal	Input/Output	Function
1	-		
2	RXD	Input	Receive data
3	TXD	Output	Transmit data
4	DTR	Output	HIGH
5	GND	-	Signal ground
6	-	-	
7	-	-	
8	-	-	
9	-	-	

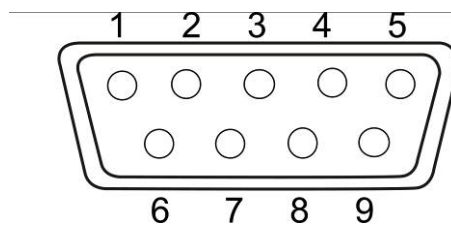

14.2. Printer interface (unidirectional data exchange)

Pin allocation of balance output plug:

Pin nr.	Signal	Input/Output	Function
1	EXT.TARE	Input	External tare function
2	-		
3	-		
4	TXD	Output	Transmit data
5	GND	-	Signal ground
6	-	-	
7	-	-	
8	-	-	

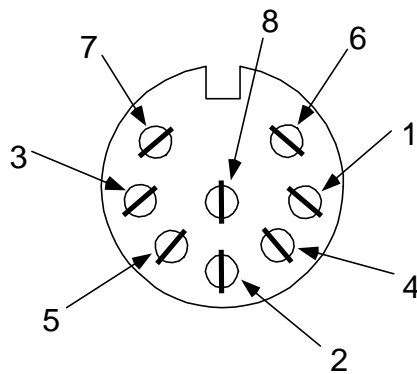

14.3. Description of interface

The selection of a certain operating mode allows you to set the output format, the output control, the transmission speed and the parity bit. The different options are described in **chpt. 7.2.2** under "parameter for serial interface".

14.4. Data output

14.4.1. Format for data transmission

Any of the data formats below may be set by selecting the relevant function on the balance (see menu overview chpt. 7.2):

- **6-digit data format**

Consisting of 14 words, including final character; CR=0DH, LF=0AH (CR=balance reverse motion / LF=line feed)

1	2	3	4	5	6	7	8	9	10	11	12	13	14
P1	D1	D2	D3	D4	D5	D6	D7	U1	U2	S1	S2	CR	LF

- **7-digit data format**

1	2	3	4	5	6	7	8	9	10	11	12	13	14	15
P1	D1	D2	D3	D4	D5	D6	D7	D8	U1	U2	S1	S2	CR	LF

NOTE: The 7-digit format is identical to the 6-digit, with the exception of the additional character D8.

- **Extended 7-digit data format**

Not documented

14.4.2. Signs

P 1 = 1 word

P1	Code	Meaning
+	2 B H	Data is 0 or positive
-	2 D H	Data is negative

14.4.3. Data

6-digit data format (D1-D7): 7 words

7-digit data format (D1-D8): 8 words

D1-D7, D8, D9	Code	Meaning
0 - 9	30 H – 39 H	Data 0 to 9 (max. 6 characters in 6-digit format)
.	2 EH	Decimal point, position not fixed
Sp	20 H	Space character, leading zero suppressed
/	2 FH	Slash "/" is inserted after the e-value.

14.4.4. Units

U 1, U 2 = 2 words as ASCII-Codes

U1	U2	Code		Meaning	Symbol
(SP)	G	20H	47H	Gram	g
K	G	4BH	47H	Kilogram	kg
C	T	43H	54H	Karat	ct
P	C	50H	43H	Qty.	Pcs
(SP)	%	20H	25H	Percent	%

14.4.5. Result evaluation for balances with tolerance range

S 1 = 1 word

S1	Code	Meaning	
L	4CH	Goods to be weighed below tolerance limit	1- or 2 end points
G	47H	Goods to be weighed within tolerance range	
H	48H	Goods to be weighed above tolerance limit	
1	31H	Limit 1	3 or 4 end points
2	32H	Limit 2	
3	33H	Limit 3	
4	34H	Limit 4	
5	35H	Limit 5	
T	54H	Value total	File Type
U	55H	Weight value	
(SP)	20H	No rating	
d	64H	Gross	

14.4.6. Data status

S 2 = 1 word

S 2	Code	Meaning
S	53 H	Data stabilized *
U	55 H	Data not stabilized (fluctuating) *
E	45 H	Data error, all data apart from S 2 unreliable Balance indicating error (o-Err, u-Err)
sp	20 H	No special status

14.4.7. Interval data output

When an interval output is started or stopped, this will result in the output of a header or footer line.

Header

- consisting of 15 words

1	2	3	4	5	6	7	8	9	10	11	12	13	14	15
-	-	-	-	-	-	-	-	-	-	-	-	-	-	-

Footers

- Two line feeds are inserted.

14.4.8. Output time

1	2	3	4	5	6	7	8
h	h	:	m	m	:	s	s

* hh: Hours (00-23), mm: Minutes (00-59) min: Seconds (00-59) s:

14.5. Remote control instructions

C1	C2	Code		Meaning
0	0	4FH	30H	No data output
0	1	4FH	31H	Continuous data output
0	2	4FH	32H	Continuous data output stable weighing values
0	3	4FH	33H	Output for stable and instable weighing values after pressing PRINT key
0	4	4FH	34H	Output for stable weighing value after previous relief of balance
0	5	4FH	35H	One output for stable weighing value. No output for stable weighing values. Renewed output after stabilization
0	6	4FH	36H	One output for stable weighing value. Continuous output for instable weighing values.
0	7	4FH	37H	Output of stable weighing values after pressing PRINT key
0	8	4FH	38H	Single immediate output
0	9	4FH	39H	Single output after stabilization
0	A	4FH	41H	Single immediate output after a determined interval
0	B	4FH	42H	Single immediate output after a determined interval and a stable weighing value

15. Service, maintenance, disposal

15.1. Cleaning

Before cleaning, please disconnect the appliance from the operating voltage.

Please do not use aggressive cleaning agents (solvents or similar agents), but a cloth dampened with mild soap suds.

The weighing terminal has a **pressure compensation device**.

This is underneath the terminal and made of a glued on membrane.

When cleaning please ensure that the **membrane is not damaged** or soiled.

15.2. Service, maintenance

The appliance may only be opened by trained service technicians who are authorized by KERN.

Before opening, disconnect from power supply.

15.3. Disposal

Disposal of packaging and appliance must be carried out by operator according to valid national or regional law of the location where the appliance is used.

16. Instant help

In case of an error in the program process, briefly turn off the balance and disconnect from power supply. The weighing process must then be restarted from the beginning.

Fault	Possible cause
The displayed weight does not glow.	<ul style="list-style-type: none"> • The balance is not switched on. • The mains supply connection has been interrupted (mains cable not plugged in/faulty). • Power supply interrupted.
The displayed weight is permanently changing	<ul style="list-style-type: none"> • Draught/air movement • Table/floor vibrations • The weighing plate is in contact with foreign matter. • Electromagnetic fields / static charging (choose different location/switch off interfering device if possible)
The weighing value is obviously wrong	<ul style="list-style-type: none"> • The display of the balance is not at zero • Adjustment is no longer correct. • Great fluctuations in temperature. • Electromagnetic fields / static charging (choose different location/switch off interfering device if possible)

Error message	Possible cause
o-Err	Weighing range exceeded
u-Err	Weighing plate has contact with other objects
b-Err	Check ambient conditions (draught, vibrations etc.)
d-Err	Damaged electronics
A-Err	Internal adjustment automatics defective
1-Err	Incorrect adjusting weight
2-Err	Divergence last external adjustment > 1%
3-Err	During the adjustment there was one weight on the weighing plate
4-Err	Divergence from last internal adjustment > 1%
7-Err	Insufficient battery capacity for adjustment

Should other error messages occur, switch balance off and then on again. If the error message remains inform manufacturer.